

VFD Applications:



Industrial Supply Syndicate

54, Ezra Street, Kolkata - 700001

Tel.: +91-33-2235 0923 / 6676. Email: info@indiameters.in | indiameters.in

High Performance AC Drives



User Manual

indiameters.in

PREFACE

This manual can provide you with the detailed rules and precautions, including installation, wiring, the setting of functional parameter, daily maintenance, malfunction diagnosis and solution etc.

To give full play to its function and ensure the safety of both users and product, please read this manual carefully before using it. Any incorrect operations may lead to fault, malfunction or shortened lifetime, even damage of device and accident casualty.

- Please pay attention to the following points when using it:
- Power must be shut off before wiring.
- Ground wire must be connected correctly.
- In any case, AC power lines can't be connected to the output terminals, such as U, V or W .
- Do not touch the internal components for safety.
- Only the qualified electronic engineer is allowed to assemble, wire, repair or maintain the converter.
- Converter must be installed in a appropriate operating environment and far away from humidity or water drops; care must be taken to prevent it from direct sunlight or being overheated.
- Do not conduct the procedure of inspection or maintenance until converter has been shut down for more than 3 minutes.
- No permission is granted to change or modify the internal components or circuits.
- Do not conduct the Withstand Voltage Test on the internal components.

This manual is enclosed randomly as an attachment, please keep it safe in case that you need it for the inspection or maintenance of this product. Any information in this manual is subject to change without notice in accordance with our policy of continuous improvement of product.

1-3 Illustrations for nameplate of FD 200

Product Model	⇒	MODEL : FD200-3-100-C-CE
Power	⇒	POWER : 10HP/7.5KW
Input Power Specification	⇒	INPUT : 10PH 415V ±15% 50/60Hz
Output Power Specification	⇒	OUTPUT : 0-400Hz 17 A
		BAR CODE
Item Number	⇒	019059037 HIGH POWERED INVERTER Selec Control Pvt. Ltd

Illustrations for product model of FD200

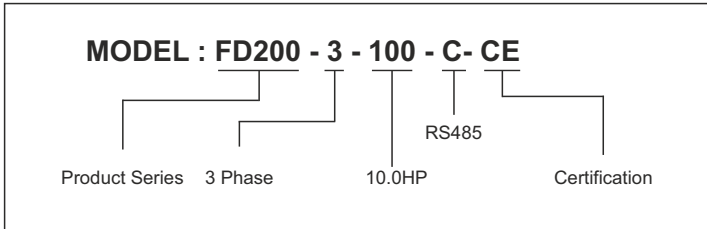

INSTALLATION

2-1 Installation environment

- No Water drops, steam, dust or oily dust surrounded.
- No caustic or inflammable gas and liquid surrounded.
- No floating dust and metal particles surrounded.
- Solid base without vibration.
- No electromagnetic or noise interference.
- Ambient temperature should be $-10^{\circ}\text{C} \sim +40^{\circ}\text{C}$; in case that the ambient temperature is higher than 40°C and that it is overheated, it should be stored in a place where there is good ventilation.

2-2 Installation instructions and space limit

- It should be installed on the fire-proof frame, for example metal frame, in case that it causes fire accidents.
- It should be mounted by screws vertically; upside-down, slant or horizontal mounting are not allowed.
- Spare space must be ensured for the ventilation of converter in case that it's overheated while it's running.
- Ventilation must be taken into consideration to ensure that ambient temperature is lower than specified value when converter is installed inside a control cabinet.
- To minimize the heat effect on each other, they should be horizontally installed abreast if two or more converters are installed in the same control cabinet; Baffle plate must be set up between them for the same reason if they have to be installed vertically.

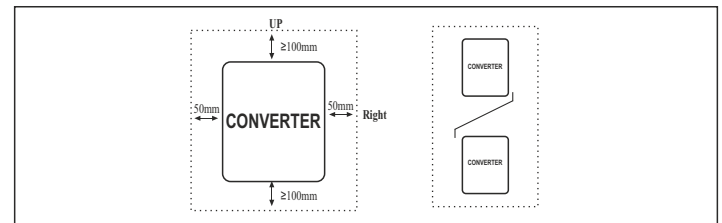

- It should be kept away from various impurity, such as fiber, paper scraps, wood chips or metal filings up.

WIRING

- (For the safety of operator as well as devices, only the qualified electronic engineer is allowed to operate it. Please pay attention to the following precautions while wiring.
- Power must be shut off before wiring.
- PE earth terminal must be connected with the ground.
- The rated voltage must be in conformity with AC voltage. Power cords must be connected with the terminal R, S and T while lines for motor should be connected with terminal U, V and W; any incorrect connection may cause damage to the internal components of converter.
- The reliability of the terminals and wires must be evaluated before wiring, and screws for the terminals of major loop must be fastened solidly.
- To avoid electric shock, do not touch the terminals of major loop.

3-1 Connection methods for assorted devices

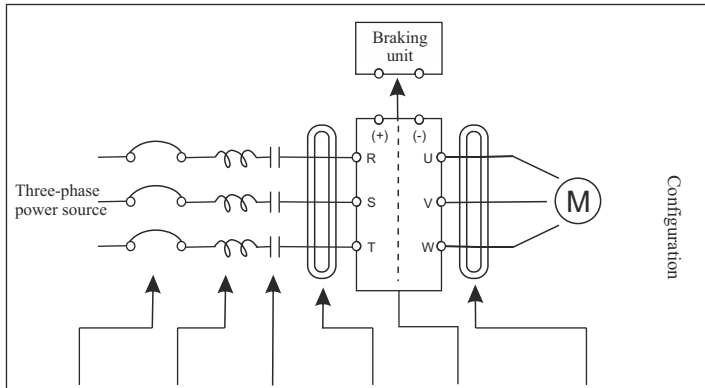

Chopper	AC reactor	Electromagnetic contactor	Filter	Braking Unit	Filter	Name
Applicable model should be selected; its rated current must be no less than 1.5 times the rated current of converter	it's applied to the improvement of input power factors	it's used to control the switching of power source	it's used to reduce the radio interference generated by converter	it's applicable when the braking torque doesn't meet basic requirements, or when inertia load is so large that converter needs to be stopped frequently or in a short time	It's used to reduce the radio interference generated by converter. But it's not applicable if the leads is too short	Descriptions

3-2-1 Standard wiring diagram for FD100

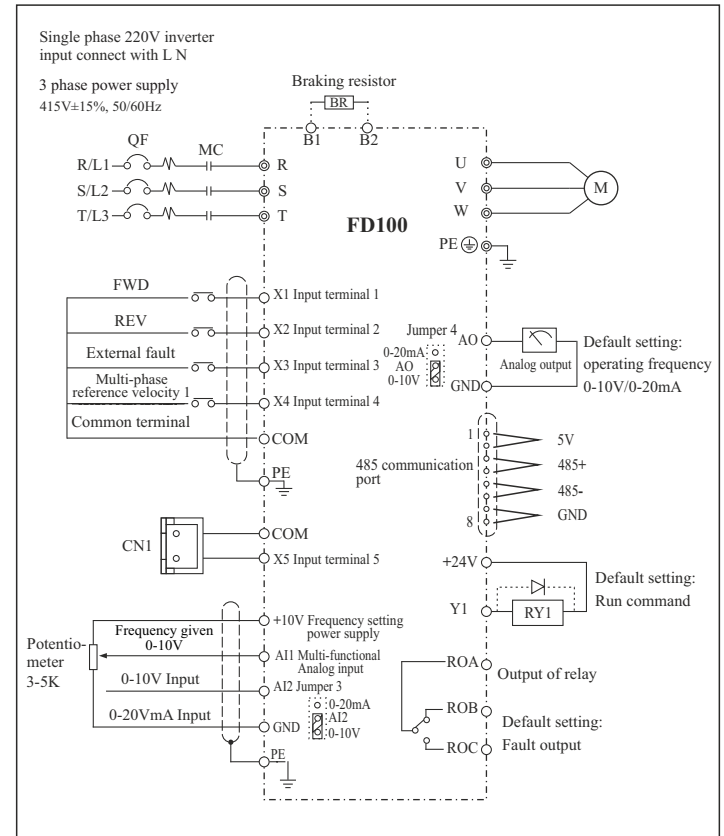

3-2-2 Standard wiring diagram for FD200

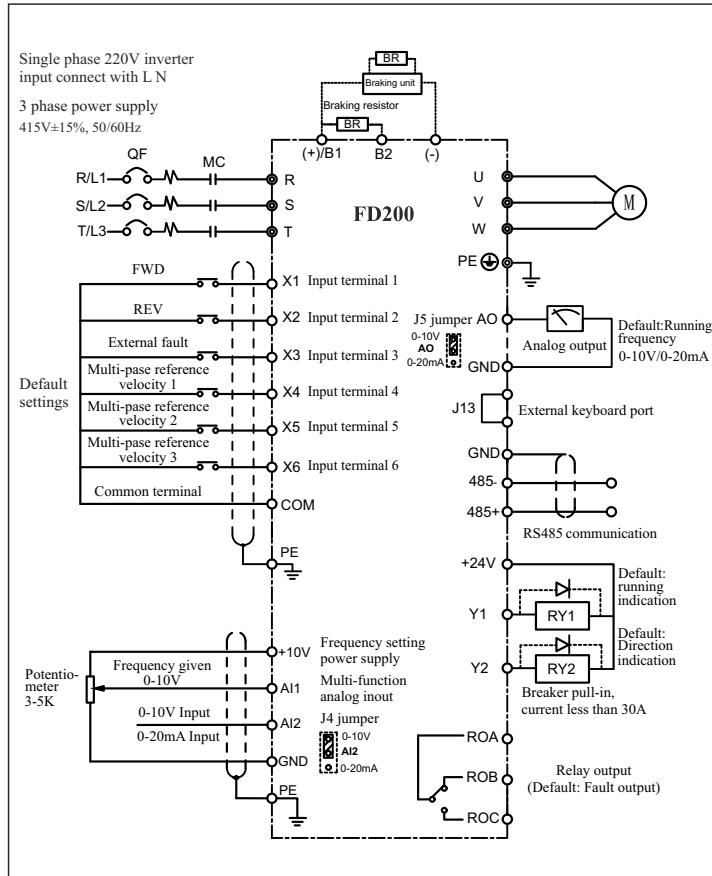

3-3 Description of major loop's terminal for FD100 & FD200 series

Terminal symbol (code)	Functional descriptions
R, S, T	Terminals for three-phase AC input 415V
L, N	Terminals for Single-phase AC input 220V
U, V, W	Output terminals, connect with three-phase AC electromotor
B1, B2	Terminals for braking resistor(optional)
(+), (-)	Terminals for external braking unit(optional)
	Terminal of ground (Earth terminal)

For safety's sake, please connect wires according to the regulations of National Electrical Code while proceeding wiring

3-3-1 Connection of input terminal R, S, T or L, N

An additional breaker/chopper must be connected in series with the terminals of major loop (R, S, T or L, N) and three-phase AC or Single-phase AC input. For better running, an electromagnetic contactor should be connected with them in series so that it could cut off the power while the protection function of converter is activated (Tip: R-C surge absorbers should be added to the ends of electromagnetic contactor. If an additional earth leakage circuit breaker(ELCB) is installed as a protective device for electric leakage, the sensitivity of current should be more than 200mA while actuation time should be no less than 0.1 second in order to prevent ELCB from malfunctioning. AC reactor must be connected with the input terminals in case that some of rectifiers are damaged by high-voltage and high-current input circuit from the grid, which could also improve the power factors of input terminals. Do not control the converter by adopting the way of powering on or off major loop. Instead of that, RUN/STOP buttons on the keyboard or control loop terminals should be applied to the control of converter; if it has to be controlled by that way, it can be implemented only once every one hour. It's feasible to reduce the interference with devices nearby by connecting an additional noise filter with the input terminals. Do not connect converter driven by three-phase power to single-phase source.

3-3-2 Connection of output terminal U, V, W

Output terminals must be connected to three-phase motor in the correct order; if motor rotates in the wrong direction, any two wires among U, V and W electrical wiring can be switched with each other.

In any case, do not connect output terminals to phasing capacitor or surge absorber. When the length of wire connecting converter with motor is more than 50 meters, there may be a large amount of electric leakage caused by the capacitors between the wiring, which may lead to over current; additionally, to protect the insulation of motor from being damaged, an additional output reactor must be installed.

An additional noise filter can be installed to reduce the electromagnetic interference of output if surroundings can be easily affected by converter; interference can also be minimized by reducing its carrier frequency.

3-3-3 Connection of braking resistors and braking unit

If inertia load is so large that converter needs to be shut off frequently or in a short time, braking resistors or braking unit should be selected and installed accordingly to solve the issue of insufficient braking capacity or lengthen braking torque.

Terminals(B1, B2) of major loop must be connected with braking resistors(Tip: terminal B1 or B2 indicates that this converter is the one with built-in braking units)

If there is no built-in braking unit, positive(+) and negative(-) terminals of major loop should be connected to external braking units.

Do not connect positive(+) and negative(-) terminals of major loop to braking resistor.

3-3-4 Earth terminal PE

For safety's sake, earth terminal PE must be well grounded in order to reduce noise. Please use the standard ground lead which should be as short and thick as possible(its grounding impedance should be no more than 10Ω)

Do not connect its ground lead with that of high-current loading machine to ground at the same time, for example welder or high-power motor, they must be grounded separately. All the converters must be connected to the same earth terminal directly if two or more converters are installed together; please refer to the wiring layout below:

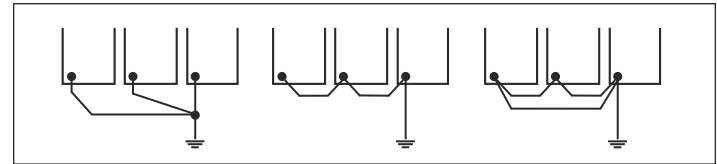

(a) correct

(b) not recommend

(c) error

3-3-4 Explanations of control loop terminals FD100

AI1	AI2	GND	AO	24V	Y1	COM	X1	X2	X3	X4	ROA	ROB	ROC
-----	-----	-----	----	-----	----	-----	----	----	----	----	-----	-----	-----

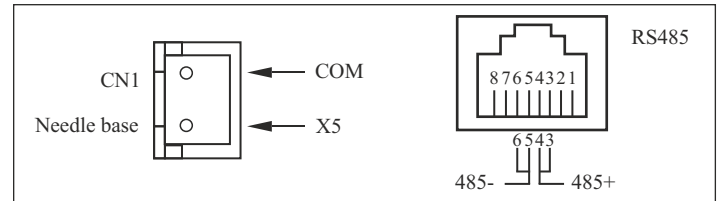

Items	Symbol	Terminal name	Terminal description & default setting
Multi-functional input	X1	Multi-functional input terminal 1	Default setting : Forward / Stop
	X2	Multi-functional input terminal 2	Default setting : Reverse / Stop
	X3	Multi-functional input terminal 3	Default setting : External fault input
	X4	Multi-functional input terminal 4	Default setting : Multi-step & speed reference 1
	X5	Multi-functional input terminal 5	Default setting : Multi-step & speed reference 2
	COM	Common terminal	Multi-functional input common terminal +24V power reference grong
Analog input	AI1	Analog input 1	0~10V input
	AI2	Analog input 2	0~10V/0~20mA input (J3 jumper is optional)

	+10V	Analog preset power source	+10V DC 10mA (potentiometer 3~5K)
	GND	Analog reference ground	Analog input output reference ground
Multi-functional output	Y1	Multi-functional output terminal 1	Default setting: running status
	ROA	Relay output ROA-ROB (normally closed) ROA-ROC (normally opened)	Default setting : Fault output
	ROB		
	ROC		
Analog output	AO	Analog output terminal	0~10V/0~20mA output (J4 jumper is optional) GND is also known as reference ground
Power source	+24V	+24V power source	+24V DC 100mA COM is also known as power ground
communication	485+	485 signal positive terminal	Standard serial communication Interface RS-485; Please use twisted pair or shielded line
	485-	485 signal positive terminal	

3-3-5 Explanations of control loop terminals for FD200

+24V	Y1	Y2	X1	X2	X3	X4	A0	485-	485+	
	ROA	ROB	ROC	COM	X5	X6	GND	AI1	AI2	+10V

Items	Symbol	Terminal name	Terminal description & default setting
Multi-functional input	X1	Multi-functional input terminal 1	Default setting : Forward / Stop
	X2	Multi-functional input terminal 2	Default setting : Reverse / Stop
	X3	Multi-functional input terminal 3	Default setting : External fault input
	X4	Multi-functional input terminal 4	Default setting : Multi-step & speed reference 1
	X5	Multi-functional input terminal 5	Default setting : Multi-step & speed reference 2

Items	Symbol	Terminal name	Terminal description & default setting
Multi-functional input	X6	Multi-functional input terminal 6	Default setting : Multi- step & speed reference 3
	COM	Common terminal	Multi-functional input common terminal +24V power reference ground
Analog input	AI1	Analog input 1	0~10V input
	AI2	Analog input 2	0~10V/0~20mA input (J4 jumper is optional)
	+10V	Analog preset power source	+10V DC 10mA (potentiometer 3~5K)
	GND	Analog reference ground	Analog input-output reference ground
Multi-functional output	Y1	Multi-functional output terminal 1	Default setting : Running status
	Y2	Multi-functional output terminal 2	Default setting : Running direction
	ROA	Relay output ROA-ROB (normally closed) ROA-ROC (normally opened)	Default setting : Fault output
	ROB		
ROC			
Analog output	AO	Analog output terminal	0~10V/0~20mA output (J5-jumper is optional) GND is also known as reference ground
Power source	+24V	+24V power source	+24V DC 100mA COM is also known as power ground
communication	485+	485 signal positive terminal	Standard serial communication interface RS-485; Please use twisted-pair or shielded line
	485-	485 signal negative terminal	

Multi-core shielded cable or stranded wire should be used to connect and control terminals. The terminal which is closed to converter must be connected to earth terminal PE while shielded cable is applied to it. When wiring, control cable must be kept away from main circuit and high-current circuit at least 20cm, such as power lines, motor wires, wires for contactor and relay. Instead of parallel wiring, vertical wiring should be adopted to prevent converter from malfunction resulted from external interference.

KEYBOARD & PANEL

4-1 Illustrations of Keyboard

4-1-1 Diagram of Keyboard for FD100

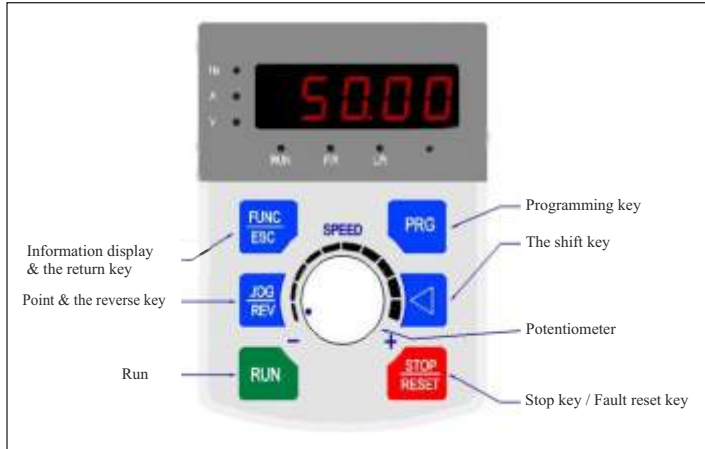

4-1-2 Indicator light show

1) Functional indicator light:



Light is the name of the	Indicator light show
RUN	Running status indicator light: When the lights went out said inverter in the down state; Light flash frequency converter in the parameter self learning state; When the light is said inverter in the running state
F/R	And reversing lamp: Said the lights went out in the forward state; The light is said in a state of inversion.
L/R	External terminal control indicator: Said the lights went out the keyboard control state; The light is said terminal control state.

2) Unit Indicator light shows :

Light is the name of the	Indicator light show
Hz	Frequency unit
A	Current unit
V	Voltage unit

3) Digital display area : Five LED display, can display setting frequency, output frequency and so on all sorts of monitoring data and alarm code.

3) Keys function description

The key symbol	The name Says	Functional specifications
PRG	Programming key	Enter the menu programming; Parameter setting for confirmation.
FUNC / ESC	Return key	Under the outage display and operation interface, recycled display status information; Return to the superior programming menu.
	Increasing the UP button	Clockwise rotation: frequency, function code, data increasing Counter clockwise rotation: frequency, function code, data decrease Middle press: select the function code or confirm the data
	Shift Key	The display status information can be displayed at the interface and the running display interface & the modification parameters can be selected.
RUN	The operation Key	Under the keyboard operation, used to run the operation.
STOP/RESET	Stop/Reset Button	Running state, press this button can be used to stop operation, the restriction of the function code P0-02; Fault alarm state, can use the key to copy a failure.
JOG/REV	Point Move/ Forward/ Reverse Key	The key function by function code P1-03 determine: 0: inching operation 1: forward reversal switch for positive & negative switching key.

4-2 Illustrations of keyboard for FD200 series

4-2-1 Diagram of keyboard FD200 series

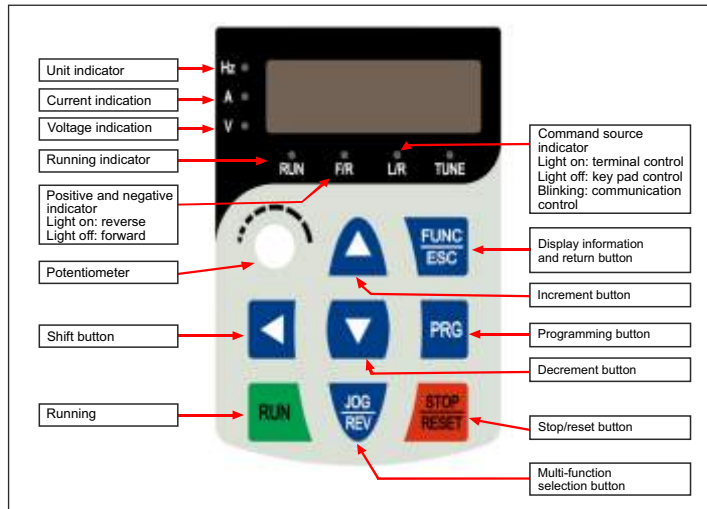

4-3 Illustrations of keyboard operation

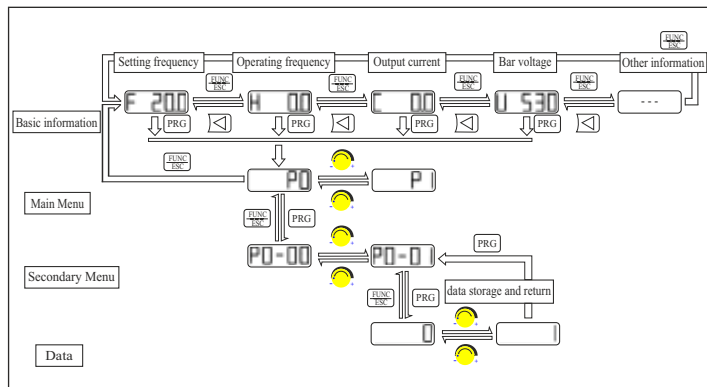

RUNNING

5-1 Commissioning

5-1-1 Check before running

- Please check whether wiring is correct or not, especially output terminals(U, V, W) which mustn't be connected to power source; additionally, earth terminals PE must be well grounded as well.
- Please confirm that there is no short circuit or line-to-ground short circuit between terminals or any exposed charged component.
- Please confirm that all the components are fastened, such as terminals, pluggable connectors or screws.
- Make sure that all the switches are off before it's connected to power source, and that converter will not malfunction or be started when it's switched on.
- Do not connect it to power s until its enclosure is assembled.

5-1-2 Commissioning

Converter must be checked and confirmed comprehensively before commissioning; its default running mode is to be controlled through keyboard and panel.

- Please push the button & check the following points (its default jog frequency is 5.0 HZ):
Whether motor is rotating in the right direction or not;
Whether its rotation is smooth or not (NO abnormal noise or vibration is permitted)
Whether the acceleration or deceleration of motor is stable.
- If converter functions properly, please preset its operating frequency first; please press the button start commissioning and check whether its output current/voltage is normal or not only after confirmation can it be power-on.

Converter must be switched off immediately by pushing the button STOP/RESET if there is anything goes wrong with converter or motor; meanwhile, please refer to Chapter 7 Fault Correcting to find out the reason why it malfunctions. Even it is shut off, output terminals(U, V, W) may still cause electric shock to anyone who touches them unless power ports(R, S, T) are disconnected from main circuit.

Additionally, it will take some times for filter capacitor to discharge because there is still charging voltage stored in the filter capacitor even main power source is shut off. Charging indicator will be off if main power source is shut off; voltage in the middle DC circuit must be tested by voltmeter. Only after it's confirmed that the voltage is lower than specified value can internal circuit be touched.

5-2 Quick debugging

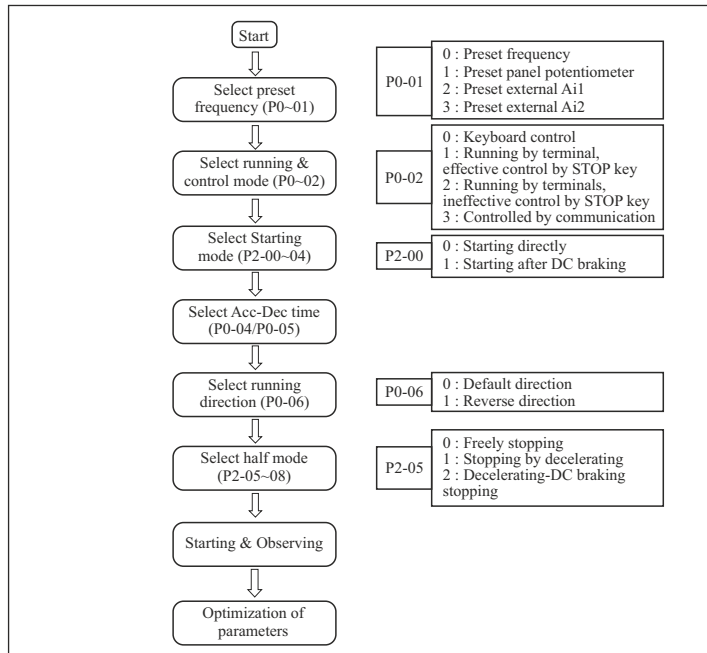

SPECIFICATION OF FUNCTIONAL PARAMETERS

6-1 Functional Parameters Table

P0: Basic functional parameters

Function Code	Description	Description and Range	Default	Modification	Modbus Address
P0-00	Parameter setting mode	0 : Enabled (except those parameters marked with"x") 1 : Disabled (except P0-00) 99 : Factory reset	0	•	40001
P0-01	Frequency setting mode	0 : Frequency setting (UP/DOWN) 1 : Panel potentiometer 2 : External Ai1 3 : External Ai2 4 : PI regulation 5 : UP/DOWN by the P5-20 add and subtract 6 : UP/DOWN by the P5-20 add and subtract, frequency zero downtime	0	•	40002
P0-02	Control mode for running	0 : Controlled by keyboard 1 : Controlled by terminals, STOP Key disabled 2 : Controlled by terminals, STOP Key enabled 3 : Controlled by communication	0	•	40003
P0-03	Frequency setting	0.0 Hz ~ Upper limiting frequency (P0-09)	50.0Hz	○	40004
P0-04	Acceleration time 0	0.1s~3600.0s	20.0s	○	40005
P0-05	Deceleration time 0	0.1s~3600.0s	20.0s	○	40006
P0-06	Running direction Option	0 : Default direction 1 : Reverse direction	0	•	40007
P0-07	Anti-Reversion Setting	0 : Enabled 1 : Disabled	0	•	40008
P0-08	Maximum frequency	Upper limit frequency (P0-09) ~ 400.0Hz	60.0Hz	•	40009
P0-09	Upper limiting frequency	Lower limiting frequency (P0-10) ~ Maximum frequency (P0-08)	50.0Hz	•	40010

P0-10	Lower limiting frequency	0.0Hz~Upper limiting frequency (P0-09)	0.0Hz	●	40011
P0-11	Jog frequency	0.0Hz~Upper limiting frequency (P0-09)	5.0Hz	○	40012
P0-12	Carrier frequency	1~16KHz	Depending on model	●	40013
P0-13	Carrier frequency Regulation	0 : Regular PWM mode 1 : Random PWM mode	0	●	40014
P0-14	Keyboard frequency setting (UP/DOWN)	0 : Automatic storage when power down 1 : No storage for power-down	0	○	40015
P0-15	Slave address for RS485 Modbus Communication	1 ~ 127 (0 for Broadcast address)	1	●	

(P0-17 Reserved)

P1: Human Interface parameters

Function Code	Description	Setting range	Default	Modification	Modbus Address
P1-00	Default display information for Starting	0 : Setting frequency 1 : Output frequency 2 : Output current 3 : Bus voltage 4 : Rotational Speed of motor 5 : Percentage of output current 6 : IGBT temperature 7 : Output voltage 8 : Output power 9 : Count value 10 : PI index value 11 : PI feedback value 12 : Accumulated running time (hour) 13 : Input terminal status 14 : Output terminal status 15 : Power	0	○	40019
P1-01	Setting of display information	0: 0~3 messages 1: 0~7 messages 2: 0~11 messages 3: 0~15 messages	1	○	40020

P1-02	Display coefficient of mechanical speed	0.1~60.0	29.0	○	40021
P0-03	JOG/REV (function selector)	0 : JOG 1 : FDW / REV switching	0	●	40022

P2: Parameters of Start-Stop Mode

Function Code	Description	Setting range	Default	Modification	Modbus Address
P2-00	Starting Mode	0 : Starting directly 1 : DC braking-Starting 2 : Speed tracking after startup 3 : Adaptive direction of speed tracking	0	●	40026
P2-01	Starting frequency	0.0~10.0Hz	0.5Hz	●	40027
P2-02	Retention time for starting	0.0~50.0 s	0.0s	●	40028
P2-03	Braking current before starting	0~150.0%	50.0%	●	40029
P2-04	Braking current before starting	0~50.0s	0.0s	●	40030
P2-05	Stop mode	0 : Regular stopping 1 : Stop by decelerating 2 : Decelerating-DC braking-Stopping	1	●	40031
P2-06	Start frequency of DC braking	0.0~10.0Hz	2.0Hz	●	40032
P2-07	Braking current for stopping	0~150.0%	50.0%	●	40033
P2-08	Braking time for stopping	0~50.0s	0.0s	●	40034
P2-09	FWD/REV Dead time	0.0~50.0 s	0.2s	●	40035
P2-10	Lower limiting frequency for running control	0 : running with lower limiting frequency 1 : stopping 2 : standby	0	●	40036

P3: Parameters of Motor

Function Code	Description	Setting range	Default	Modification	Modbus Address
P3-00	Rated frequency	F3 (P4-05) ~ 400.0Hz	50.0Hz	●	40039
P3-01	Rated voltage	200 ~ 440V	Depending on model	●	40040
P3-02	Rated current	0.1 ~ 999.9A	Depending on model	●	40041
P3-03	Rated power	0.1 ~ 630.0KW	Depending on model	●	40042
P3-04	Rated rotational Speed	1 ~ 3600rpm	1440rpm	●	40043
P3-05	No-load current	0.1 ~ 999.9A	Depending on model	●	40044
P3-06	Stator resistance	0.001 ~ 50.000Ω	Depend on model	●	40045
P3-07	Excitation/Magnetic inductance	0.1 ~ 5000.0mH	Depend on model	●	40046

(P3-08 ~ P3-12 Reserved)

P4: V/F Control Parameters

P4-00	V/F curve setting	0: General V/F 1: 2 power V/F 2: 3 power V/F 3: high starting torque V/F 4: Self-setting V/F 5: Self-adaptive control	0	●	40052
P4-01	V/F Intermediate frequency 1	0.0Hz~ F2 (P4-03)	1.0Hz	●	40053
P4-02	V/F Intermediate voltage 1	0 ~ rated voltage (P3-00)	5V	●	40054
P4-03	V/F Intermediate frequency 2	F1 (P4-01)~F3 (P4-05)	5.0Hz	●	40055
P4-04	V/F Intermediate voltage 2	0 ~ rated voltage(P3-00)	25V	●	40056
P4-05	V/F Intermediate Frequency 3	F2 (P4-03) ~ rated frequency (P3-00)	25.0Hz	●	40057
P4-06	V/F Intermediate voltage 3	0 ~ rated voltage (P3-00)	115V	●	40058
P4-07	Torque upgrade	0.0 ~ 15.0%	5.0	●	40059
P4-08	Slip compensation	0.0 ~ 10.0Hz	0.0 Hz	●	40060
P4-09	AVR function	0: Disabled 1: always enabled 2: only enabled in process of deceleration	0	●	40061
P4-10	Energy-efficient running	0: Disabled 1: Enabled	0	●	40062

(P4-11~ P4-18 Reserved)

P5: Input function parameters

Function Code	Description	Setting range	Default	Modification	Modbus Address
P5-00	AI1 lower limiting value	0~10.00V	0.05V	●	40071
P5-01	Corresponding setting for AI1 lower limit	0~100.0%	0.0%	●	40072
P5-02	AI1 upper limiting value	AI1 lower limiting value~10.00V	10.00V	●	40073
P5-03	Corresponding setting for AI1 upper limit	0~100.0%	100.0%	●	40074
P5-04	AI1 input filtering time	0.0s~10.0s	0.1s	●	40075
P5-05	AI2 lower limiting value	0.00V~10.00V	0.05V	○	40076
P5-06	Corresponding setting for AI2 lower limit	0~100.0%	0.0%	○	40077
P5-07	AI2 upper limiting value	AI2 lower limiting value~10.00V	10.00V	○	40078
P5-08	Corresponding setting for AI2 upper limit	0~100.0%	100.0%	○	40079
P5-09	AI2 input filtering time	0.0s~10.0s	0.1s	○	40080
P5-10	Multi functional Input Terminal X1	0 : Disabled 1 : Forward 2 : Reverse	1 Forward	●	40081
P5-11	Multi functional Input Terminal X2	3 : Three-wire control 4 : Multi-phase reference velocity 1	2 Reverse	●	40082
P5-12	Multi functional Input Terminal X3	5 : Multi-phase reference velocity 2	14 Fault	●	40083

P5-13	Multi-functional Input Terminal X4	6: Multi-Phase reference velocity 3 7: JOG forward 8: JOG reverse 9: Increasing frequency 10: Decreasing frequency 11: Acc-Dec time Option 1 12: Acc-Dec time Option 2 13: Stop of Acc/Dec 14: External fault Input 15: Fault reset 16: Regular stopping 17: External count value input 18: count clear 19: program run 20: pause of program run	4 ref. velocity 1	•	40084
P5-14	Multi-functional Input Terminal X5 (CN1 needle base input)		5 ref. velocity 2	•	40085
P5-15	Multi-functional Input Terminal X6		Reserved	•	40086
P5-16	Multi-functional Input Terminal X7		Reserved	•	40087
P5-17	Multi-functional Input Terminal X8		Reserved	•	40088
P5-18	Terminal control mode		0: Two-wire control mode 1 1: Two-wire control mode 2 2: Three-wire control mode 1 3: Three-wire control mode 2	0	•
P5-19	Terminal filtering time	2ms~100 ms	10 ms	○	40090
P5-20	The range of the UP/DOWN increasing decline	0.0~50.0Hz	0.1	○	40091

(P5-20~ P5-30 Reserved)

P6: Output function parameters

Function Code	Description	Setting range	Default	Modification	Modbus Address
P6-00	Y1 output options	0: Disabled, 1: Running 2: Direction, 3: Fault output 4: On standby 5: Frequency received 6: FDT	1	○	40102
P6-01	Y2 output options	7: Upper limiting frequency received 8: Lower limiting frequency received 9: Setting count value received 10: Designated count value received	2	○	40103
P6-02	Relay output options		3	○	40104
P6-03	AO1 options	0: Operating frequency 1: Output current 2: Bus voltage 3: Output voltage	0	○	40105
P6-04	AO1 correction coefficient	0.0~250.0%	100.0%	○	40106
P6-05	Stop delay time setting	0~3000.0s	0	○	40107

(P6-06~ P6-08 Reserved)

P7: PI control parameters

Function Code	Description	Setting range	Default	Modification	Modbus Address
P7-00	PI preset source options	0 : Digital keyboard 1 : Panel potentiometer 2 : Analog channel AI1 3 : Analog channel AI2	0	○	40111
P7-01	PI set value	0.00~10.00 V	0.00V	○	40112
P7-02	PI feedback source options	0 : Analog channel AI1 1 : Analog channel AI2	0	○	40113
P7-03	PI output characteristics options	0: Positive 1: Negative	0	○	40114

P7-04	Proportional gain (P)	0.0 ~ 10.0	1.0	○	40115
P7-05	Integral time (I)	0.0 ~ 100.0s	1.0s	○	40116
P7-06	Deviation limit	0.00 ~ 2.00	0.02	○	40117
P7-07	Sampling period(T)	0.1 ~ 100.0s	0.02s	○	40118
P7-08	Detected value of feedback disconnection	0.00 ~ 5.00	0.0	○	40119
P7-09	Time for detecting feedback disconnection	0.0 ~ 100.0s	10.0s	○	40120
P7-12	Sleep time	0 ~ 3000S	600	○	40123
P7-13	Dormancy pressure	0 ~ 10.00	0	○	40124
P7-14	Dormancy frequency	0 ~ 0.0Hz	0	○	40125
P7-15	Wake up the pressure	0 ~ 10.00	0	○	40126

P8: Simple PLC and Multispeed Parameters

Function Code	Description	Setting range	Default	Modification	Modbus Address
P8-00	Program run mode	0: Disabled 1: Program stop after one cycle of running 2: Program operates as last program runs after one cycle of running 3: Circulatory running of program	0	●	40127
P8-01	First phase speed	Lower limiting frequency ~ Upper limiting frequency	11.0Hz	○	40128
P8-02	Second phase speed	Lower limiting frequency ~ Upper limiting frequency	12.0Hz	○	40129
P8-03	Third phase speed	Lower limiting frequency ~ Upper limiting frequency	13.0Hz	○	40130
P8-04	Forth phase speed	Lower limiting frequency ~ Upper limiting frequency	14.0Hz	○	40131

P8-05	Fifth phase speed	Lower limiting frequency ~ Upper limiting frequency	15.0Hz	○	40132
P8-06	Sixth phase speed	Lower limiting frequency ~ Upper limiting frequency	16.0Hz	○	40133
P8-07	Seventh phase speed	Lower limiting frequency ~ Upper limiting frequency	17.0Hz	○	40134
P8-08	Runtime of principal frequency	0~6400.0	0.0	○	40135
P8-09	First phase time	0~6400.0	0.0	○	40136
P8-10	Second phase time	0~6400.0	0.0	○	40137
P8-11	Third phase time	0~6400.0	0.0	○	40138
P8-12	Forth phase time	0~6400.0	0.0	○	40139
P8-13	Fifth phase time	0~6400.0	0.0	○	40140
P8-14	Sixth phase time	0~6400.0	0.0	○	40141
P8-15	Seventh phase time	0~6400.0	0.0	○	40142
P8-16	Time unit of multi-velocity	0 : second 1 : minute 2 : hour	0	●	40143
P8-17	Running directions of programs	0~255 BIT 0~7 indicates 0~7 directions (0 : Forward 1: Reverse)	0	●	40144
P8-18	Timing for each program's Acc- Dec	0~65535 BIT0~15 indicates Acc-Dec time of 0~7 phase	0	○	40145

P9: Protection Function parameters

Function Code	Description	Setting range	Default	Modification	Modbus Address
P9-00	Options for overload protection	0 : Disabled 1 : Enabled	0	●	40148
P9-01	Critical point of overload protection	50~120%	110%	●	40149
P9-02	Overvoltage protection	0 : Disabled 1: Enabled	1	●	40150
P9-03	Critical point of Overvoltage	110.0~150.0%	118	●	40151
P9-04	Over-current protection	0: Disabled 1: Enabled	1	●	40152
P9-05	Critical point of over-current	100~180%	180	●	40153
P9-06	Phase-failure protection of input	0 : Disabled 1 : Enabled	0	●	40154
P9-07	Phase-failure protection of output	0 : Disabled 1 : Enabled	0	●	40155
P9-08	Latest fault information	0~20		×	40156
P9-09	Latest fault information	0~20		×	40157
P9-10	Latest two fault messages	0~20		×	40158
P9-11	Operating frequency of latest fault			×	40159
P9-12	Output current of latest fault			×	40160
P9-13	Bus voltage of latest fault			×	40161
P9-14	Input state of latest fault			×	40162
P9-15	Output state of latest fault			×	40163
P9-16	Fault since the reset function	0 : invalid 1 : under-voltage fault alarm automatic reset (unlimited) 2 ~ 20 : fault self-recovery	0	●	40164

(P9-17 Reserved)

Parameters of PA Enhancements

Function Code	Description	Setting range	Default	Modification	Modbus Address
PA-00	Acceleration time 1	0.0~3600.0s	20.0s	○	40166
PA-01	Deceleration time 1	0.0~3600.0s	20.0s	○	40167
PA-02	Acceleration time 2	0.0~3600.0s	20.0s	○	40168
PA-03	Deceleration time 2	0.0~3600.0s	20.0s	○	40169
PA-04	Acceleration time 3	0.0~3600.0s	20.0s	○	40170
PA-05	Deceleration time 3	0.0~3600.0s	20.0s	○	40171
PA-06	Jog acceleration time	0.0~3600.0s	5.0s	○	40172
PA-07	Jog acceleration time	0.0~3600.0s	5.0s	○	40173
PA-08	Hopping frequency 1	0.0~Upper limiting frequency (P0-09)	0.0Hz	○	40174
PA-09	Hopping frequency 2	0.0~Upper limiting frequency (P0-09)	0.0Hz	○	40175
PA-10	Amplitude of Hopping frequency	0.0~Upper limiting frequency (P0-09)	0.0Hz	○	40176
PA-11	FDT level value	0.0~Upper limiting frequency (P0-09)	0.0Hz	○	40177
PA-12	FDT lagged value	0.0~FDT level value (PA-12)	0.0Hz	○	40178
PA-13	Amplitude of Detected frequency FAR	0.0~Upper limiting frequency (P0-09)	0.0Hz	○	40179
PA-14	Setting count value	1~65535	10	○	40180
PA-15	Specified count value	1~65535	10	○	40181
PA-16	Under locking function for overload	0: Disabled 1: Enabled	1	●	40182

(PA-17~ PA-26 Reserved)

“o” : It indicates that it's only when converter is running or shut down on the condition that P0-00 equals zero that code parameters can be changed or modified.

“●” : It indicates that code parameters cannot be changed or modified while converter is running.

“x” : It indicates that code parameters are read-only, which cannot be changed or modified.

6-2 Detailed of function parameters (Explanations of Functional Parameters)

P0 Basic functional parameters



P0-00	Parameter setting mode	0 : Enabled (except those parameters marked with"x") 1 : Disabled (except P0-00) 99 : Factory reset	Default : 0
--------------	------------------------	---	-------------

• It's mainly applied to the setting of functional parameters; "factory reset" option should be used with caution, especially after all these parameters are set.

P0-01	Frequency setting mode	0 : Frequency setting (UP/DOWN) 1 : Panel potentiometer ; 2 : External AI1 3 : External AI2 ; 4 : PI regulation 5 : UP/DOWN by the P5-20 add & subtract 6 : UP/DOWN by the P5-20 add & subtract, frequency qing zero downtime	Default : 0
--------------	------------------------	---	-------------

• It's mainly applied to the setting of functional parameters; "factory reset" option should be used with caution, especially after all these parameters are set.

0 : Frequency setting

The frequency of converter can be preset by parameter P0-03; frequency can be preset or changed directly through these   two keys on the panel when state information is displayed; it also can be changed directly by external terminals UP/DOWN when they are enabled.

1 : Panel potentiometer

Operating frequency can be set by the potentiometer on the panel.

2/3 : Preset of external analog voltage AI1 /AI2 Operating frequency not only can be set by the signal of external analog voltage(0.0~10.0V) sent out by AI1 or AI2 whose input voltage is formed by the synergy of internal +10V power source and potentiometer. AI2 can be done through the signal of external analog current (0~20mA) via J4 jumper.

4 : PI regulation



Precaution: Corresponding multi speed frequency will be applied firstly when external multi speed terminals are enabled.



For detailed information, please refer to the standard wiring diagram on Chapter 3.

5, 6 : frequency by external terminals given (note: each time the increase or decrease of a given frequency range be determined by the P5-20), when set to 6, the frequency converter after every stop, zero frequency

P0-02	Control mode for running	0 : Controlled by keyboard 1 : Controlled by terminals, STOP Key disabled 2 : Controlled by terminals, STOP Key enabled 3 : Controlled by communication	Default: 0
--------------	--------------------------	--	------------

• It's mainly applied to the instruction sources of booting, stopping or jog for converter.

0 : Converter can be controlled through the following three keys    which stand for booting, stopping, jog or forward/reverse accordingly.

- 1 :  key will be disabled when converter is controlled by external terminals, including its booting, stopping, jog or forward/reverse running.
2 :  key will be enabled when converter is controlled by external terminals, including its booting, stopping, jog or forward/reverse running.
3 : This will allow user to control the parameters by communication.

P0-03	Frequency setting	0.0 Hz ~Upper limiting frequency (P0-09)	Default: 50.0Hz
--------------	-------------------	--	-----------------

• Frequency of output can be set by setting this parameter only when P0-01 equals zero.

P0-04	Acceleration time 0	0.1s~3600.0s	Default: 20.0s
P0-05	Deceleration time 0	0.1s~3600.0s	Default: 20.0s

- Acceleration time 0 : Time for converter to increase its frequency from 0Hz to maximum frequency (P0-08).
- Deceleration time 0 : Time for converter to decrease its frequency from maximum frequency (P0-08) to 0Hz.

Please refer to following graph.:

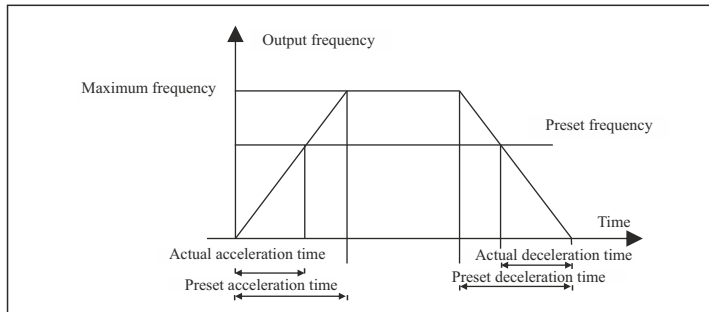

P0-06	Running direction option	0 : Default direction 1 : Reverse direction	Default: 0
--------------	--------------------------	--	------------

- Running direction can be preset through this parameter, which will also be taken as forward direction by default. It will also be chosen as a reference for reverse direction which is controlled by key as well as external terminals
0 : Converter will be running in default direction
1 : Running direction will be changed, which also means that it is changed by altering any two of motor wires(U, V, W).

P0-07	Anti-reversion Setting	0 : Enabled 1 : Disabled	Default: 0
--------------	------------------------	-----------------------------	------------

- Running direction will be controlled by parameter "P0-06" when reverse direction is disabled. Both key and external terminals will be disabled.

P0-08	Maximum Frequency	Upper limit frequency (P0-09) ~ 400.0Hz	Default: 60.0Hz
--------------	-------------------	---	-----------------

- The setting of Acc-Dec time is based on maximum output frequency of running.

P0-09	Upper limiting frequency	Lower limiting frequency (P0-10) ~ Maximum frequency (P0-08)	Default: 50.0Hz
P0-10	Lower limiting frequency	0.0Hz ~ Upper limiting frequency (P0-09)	Default: 0.0Hz

- It's mainly applied to the setting of the amplitude between upper limiting frequency and lower limiting frequency, which are also the range values of frequency regulation displayed on the panel potentiometer.
- These two parameters are also related to the amplitude of upper limiting voltage and lower limiting voltage set by AI1 or AI2. For detailed information, please refer to P5-00~08.

P0-11	Jog frequency	0.0Hz ~ Upper limiting frequency (P0-09)	Default: 5.0Hz
--------------	---------------	--	----------------

- It's mainly applied to the setting of running frequency for jog.

P0-12	Carrier frequency	1~16KHz	Default: Depending on model
--------------	-------------------	---------	-----------------------------

- The switching frequency of interior power module is controlled by this parameter.

Audio noise and heat effect generated during the process of running are mainly affected carrier frequency. Carrier frequency must be increased slightly in order to achieve a quieter running; however, the maximum load will be decreased somehow at the same time, which may increase the risk of electric leakage between motor lines or between wires and earth. When ambient temperature is too high or there is too much load for motor, carrier frequency should be decreased properly to improve converter's thermal characteristics.

Generally, carrier frequency will be preset right before delivery; therefore, it doesn't need to be reset or modified. It should be used by derating if the carrier frequency which is being applied by operator exceeds the default value preset by factory.

P0-13	Carrier frequency Regulation	0 : Regular PWM mode 1 : Random PWM mode	Default: 0

- Noise frequency of motor is fixed while running in regular PWM mode; frequency domain of noise is wider while the running of motor is set in random PWM mode.

P0-14	Keyboard frequency (UP/DOWN)	0 : Automatic storage when it powers down 1 : No storage when it powers down	Default: 0

- It's mainly used to alter the operating frequency through ▲ ▼ keys or external terminals UP/DOWN. Whether a modified operating frequency would be saved in the parameter P0-03 after it powers down depends on the setting of this parameter.

P1: Human Interface parameters

P1-00	Default display information for Starting	0 : Setting frequency	Default: 0
		1 : Output frequency	
		2 : Output current	
		3 : Bus voltage	
		4 : Rotational Speed of motor	
		5 : Percentage of output current	
		6 : IGBT temperature	
		7 : Output voltage	
		8 : Output power	
		9 : Count value	
		10 : PI index value	
		11 : PI feedback value	
		12 : Accumulated running time (hour)	
		13 : Input terminal status	
		14 : Output terminal status	
15 : Power			

- It's mainly applied to the setting of default display information for starting.

Set Value	Status Information	Discriptions	Unit
0		Preset Frequency	Hz
1		Output Frequency	Hz
2		Output Current	A
3		Bus Voltage	V
4		Rotational speed of motor	r / min
5		Percentage of output current	
6		IGBT Temperature	°C
7		Output Voltage	V

8		Output Power	KW
9		Count value	
10		PI preset value	
11		PI feedback value	
12		Total run time	H
13		Status of input terminal	
14		Status of output terminal	
15		Converter power	KW

P1-01	Setting of display information	0 : 0~3 messages 1 : 0~7 messages 2 : 0~11 messages 3 : 0~15 messages	Default: 1
--------------	--------------------------------	--	------------

- It's mainly applied to the setting for how many messages are allowed to displayed on the panel. About the corresponding information for No. 0~15, please refer to P1-00.

P1-02	Display coefficient of mechanical speed	0.1~60.0	Default: 29.0
--------------	---	----------	---------------

- It's mainly applied to the adjustment of displayed value for the rotational speed of motor. Display coefficient of mechanical speed = rotational speed of motor / operating frequency

P1-03	JOG / REV Function selection	0 : Jog 1 : FDW/REV switching	Default: 0
--------------	------------------------------	----------------------------------	------------

- It's mainly applied to the features setup of key; and when running is under the control of keyboard:
0: Jogging will be enabled by pressing key;
1: Forward direction and reverse direction can be switched to each other by key.

P2 : Parameters of Start-Stop Mode

P2-00	Starting Mode	0: Starting directly 1: DC braking-Starting 2 : Speed tracking after startup 3 : Adaptive direction of speed tracking	Default: 0
--------------	---------------	--	------------

- 0: It starts directly with the original start frequency;
- 1: DC braking-Starting – DC braking will be enabled first; then motor starts running with the original start frequency; this is applicable for the situation when reverse may be caused by small inertia load during the process of starting.
- 2: The speed tracking after startup. Frequency converter for motor speed, but the motor according to the last stop in the direction of the direction to run by default. (11 kw models more effective)
- 3: adaptive direction of speed tracking. Before starting the inverter in the automatic detection the direction of the electric motor no impact on the smooth startup of rotation of the motor. (11 kw models more effective)

P2-01	Starting frequency	0.0~10.0Hz	Default: 0.5 Hz
P2-02	Retention time for starting	0.0~50.0 s	Default: 0.0s

- Applicable starting frequency can ensure that there is enough torque for starting. Retention time for starting is needed for the formation of magnetic flow while motor is on standby, so that it can start accelerating after start frequency is stabilized for a certain time.

P2-03	Braking current before starting	0~150.0%	Default: 50%
P2-04	Braking time before starting	0~50.0 s	Default: 0.0s

- It's only when P2-00 equals 1 that DC braking can be enabled before starting. When converter is about to be started, DC braking should be proceeded according to the preset braking current(P2-03); after the preset braking time(P2-04) is over, it will start running.
- Braking current means the percentage comparing with rated current. The higher braking DC is, the stronger braking force will be.

P2-05	Stop Mode	0 : Regular stopping	Default: 1
		1 : Stop by decelerating	
		2 : Decelerating - DC braking - Stopping	

- It's mainly applied to the setting of stop mode for converter.

0: Regular stopping - the output of converter will be blocked immediately once stop instruction comes into effect.

1: Stopping by decelerating -- output frequency will be decreased slowly according to the preset deceleration time once stop instruction comes into effect; when it comes to zero, converter will be shut down.

2: Decelerating - DC braking - Stopping: output frequency will be reduced down to start frequency(P2-06) according to the preset deceleration time once stop instruction comes into effect; since then, DC braking will be enabled; after braking time(P2-08) is over, converter will be shut down.

P2-06	Start frequency of DC braking	0.0 ~ 10.0Hz	Default: 2.0Hz

- If parameter P2-05 equals two, it will be stopped through DC braking when converter reaches up to the corresponding frequency.

P2-07	Braking current before starting	0 ~ 150.0%	Default: 50.0%
P2-08	Braking time before starting	0 ~ 50.0s	Default: 0.0s

- Braking current for stopping means the amperage of direct current for braking; the higher the amperage is, the stronger the braking force will be. Braking time for stopping means the time for increasing enough amperage of direct current to stop converter; when the value comes to zero, it means that there is no DC braking during the process.

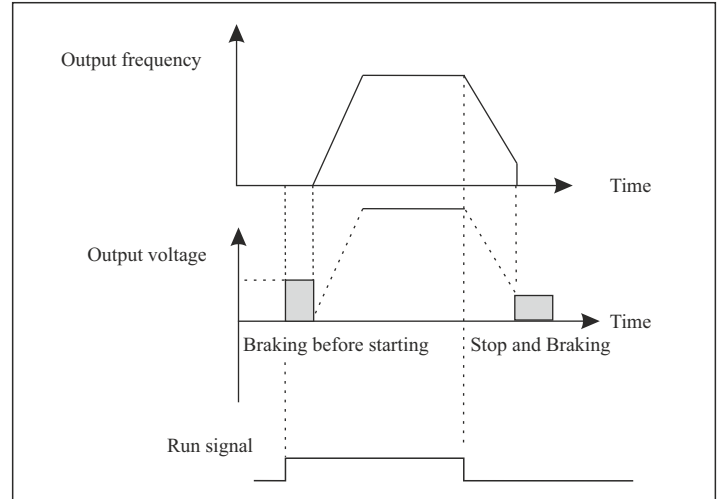

P2-09	Dead time of FWD / REV	0.0~50.0 s	Default: 0.2s
--------------	------------------------	------------	---------------

- It mainly applied to the setting of transient time for zero output frequency during the transient process between forward and reverse.

Please refer to the following graph:

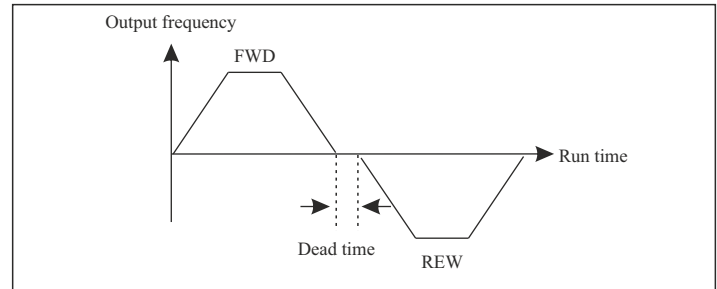

P2-10	Lower limiting frequency for running control	0 : running in lower limiting frequency	Default: 0
		1 : on stand by 2 : stopping	

- It's mainly applied to the setting of running status when preset frequency is less than lower limiting frequency.

0: Converter will be running in lower limiting frequency if preset frequency is less than lower limiting frequency.

1: Converter will be shut down when preset frequency is less than lower limiting frequency; and it will be started again automatically when preset frequency is higher than or equivalent to lower limiting frequency.

2: This parameter is applicable to stop the converter in case that motor keeps running in a low speed.

P3: Parameters of Motor

P3-00	Rated frequency	F3 (P4-05) ~ 400Hz	Default: 50.0Hz
P3-01	Rated voltage	200 ~ 440V	Default: Depending on model
P3-02	Rated current	0.1 ~ 999.9A	Default: Depending on model
P3-03	Rated power	0.1 ~ 630.0KW	Default: Depending on model
P3-04	Rated rotational speed	1 ~ 3600rpm	Default: 1440rpm

- These parameters above must be set according to the information of nameplates on the motor.

These parameters of motor must be accurate in order to improve the performance of self-adaptive control. These parameters of typical four-pole motor which is compatible with this converter by default are included, which should be input when the capacity of motor is not in conformity with that of this converter.

P3-05	No-load current	0.1 ~ 999.9A	Default: Depending on model
P3-06	Stator resistance	0.001 ~ 50.000Ω	Default: Depending on model
P3-07	Excitation/Magnetic inductance	0.1 ~ 5000.0mH	Default: Depending on model

These parameters above are mainly applied to the setting of basic electrical parameters, which are essential to complete the algorithm of self-adaptive control.

If the capacity of the matched motor is also the same as that of typical motor, the default parameters can be applicable.

They can also be input manually if those precise parameters can be obtained in advance. All the internal default parameters will be restored automatically according to its model during the process of initialization.

Precaution : Do not change or modify these parameters casually.

P4: V/F Control Parameters

P4-00	V/F curve setting	0 : General V/F	Default: 0
		1 : 2 power V/F 2 : 3 power V/F 3 : high starting torque V/F 4 : Self-setting V/F 5 : Self-adaptive control	

- It's mainly applied to the setting of corresponding curves for output voltage and output frequency according to different conditions of loading.

0: General V/F is generally applicable to constant load torque;

- 1/2 : 2 or 3 power V/F is applicable to the operation with centrifugal load, for example draught fan or pump, etc.

3 : high starting torque V/F is applicable to the operating situations which require higher starting torque.

4 : Self-setting V/F indicates that V/F curve can be preset randomly by the functional codes P4-01~P4-06, which is applicable to the operation with special load, for example dewaterer or centrifuge, etc.

5 : Self-adaptive control can be applied to running regulation by adapting itself to actual load automatically, which is applicable to the operating situations which require greater low-frequency torque as well as strict control on speed.

Parameters must be set correctly according to the information of nameplate on the motor if this function needs to be enabled; it's only when the capacity of the motor is the same as that of this converter can its performance be improved greatly.

P4-01	V/F Intermediate frequency 1	0.0Hz~P4-03 (Intermediate frequency 2)	Default: 1.0Hz
P4-02	V/F Intermediate voltage 1	0~ rated voltage (P3-00)	Default: 5V
P4-03	V/F Intermediate frequency 2	P4-01(Intermediate frequency 1)~P4-05 (Intermediate frequency)	Default: 5.0Hz
P4-04	V/F Intermediate voltage 2	0~ rated voltage (P3-01)	Default: 25V
P4-05	V/F Intermediate frequency 3	P4-03 (Intermediate frequency 2) ~ P3-00 (rated frequency)	Default: 25.0Hz
P4-06	V/F Intermediate voltage 3	0~ rated voltage (P3-01)	Default: 115V

- Multiple-phase V/F curves can be defined by these six parameters above (P4-01~ P4-06)
The set value of V/F curves is generally set according to the load characteristics of motor.

Precaution : motor may be overheated or even burned if preset low-frequency voltage is too high, which may activate its over current protection.
 $V1 < V2 < V3$, $F1 < F2 < F3$.

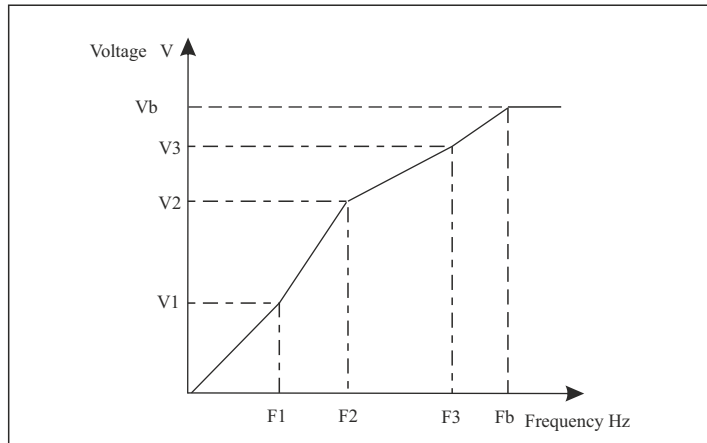

P4-07	Torque upgrade	0.0~15.0%	Default: 5.0
-------	----------------	-----------	--------------

- This parameter can make compensation for output voltage when converter is running in a low frequency, so that the characteristics of low-frequency torque which is controlled by V/F can be compensated and upgraded.

If the setting of torque upgrade is too high, not only motor tends to be overheated but also over current may be caused by it. In general, the setting of torque upgrade must be no more than 10%. To prevent converter from over current effectively, this parameter must be adjusted properly. This parameter should be increased whenever there is heavy load; otherwise, please decrease this parameter.

P4-08	Slip compensation	0.0~10.0Hz	Default: 0.0Hz
-------	-------------------	------------	----------------

- The practical slip of motor varies from load to load. Output frequency can be adjusted automatically according to the condition of loading by this functional parameter, so that compensation can be made for the influence of load on rotational speed of motor.

P4-09	AVR function	0 : Disabled 1 : always enabled 2 : only enabled in process of deceleration	Default: 0
-------	--------------	---	------------

- AVR function is also known as Automatic Voltage Regulation function. Adjustment will be made automatically to stabilize output voltage whenever there is fluctuation of input voltage, so that it can prevent converter from overheat of motor caused by high output voltage or poor performance caused by low output voltage.

P4-10	Energy-efficient running	0 : Disabled 1 : Enabled	Default: 0
-------	--------------------------	-----------------------------	------------

- During the process of no-load or light-load running, output voltage can be adjusted properly to achieve automatic energy conservation by detecting load current. This parameter is applicable to the load of draught fan or pump.

P5: Input function parameters

P5-00	AI1 lower limiting value	0~10.00V	Default: 0.05V
P5-01	Corresponding setting for AI1 upper limit	0~100.0%	Default: 0.0%
P5-02	AI1 upper limiting value	AI1 lower limiting value~10.00V	Default: 10.00V
P5-03	Corresponding setting for AI1 upper limit	0~100.0%	Default: 100.0%
P5-04	AI1 input filtering time	0.0s~10.0s	Default: 0.1s

- The functional codes above define the relationships between analogue input voltage and corresponding setting of AI. Calculation will be based on the maximum or minimum one whenever analogue input voltage exceeds the range between preset maximum input and minimum input. The corresponding nominal value of analogue setting varies from situation to situation.

For detailed information, please refer to the relevant instructions for each parameter.

The following graphs are listed to demonstrate several situations of setting.

Precaution : Preset lower limiting value of AI1 must be less than or equivalent to preset upper limiting value of AI1.

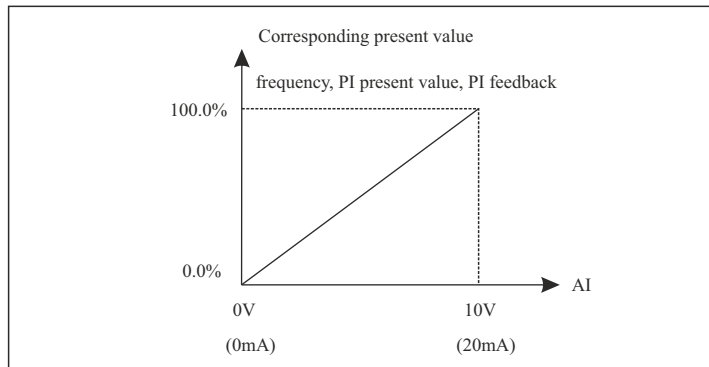

The sensitivity of analog input is decided by AI1 input filtering time. The parameter must be increased to improve the anti-jamming capability which can prevent analog quantity from being interfered, so malfunctions can be reduced somehow; however, it may reduce the sensitivity of analog input.

P5-05	AI2 lower limiting value	0~10.00V	Default: 0.05V
P5-06	Corresponding setting for AI2 upper limit	0~100.0%	Default: 0.0%
P5-07	AI2 upper limiting value	AI2 lower limiting value~10.00V	Default: 10.00V
P5-08	Corresponding setting for AI2 upper limit	0~100.0%	Default: 100.0%
P5-09	AI2 input filtering time	0.0s~10.0s	Default: 0.1s

- The setting of AI2 function is similar to that of AI1. 0~20mA input current is equivalent to 0~10V input voltage when analogue input is preset as current input. 0~10V or 0~20mA input can also be selected through jumper 4(J4).

P5-10	Multi-functional Input Terminal X1	0 : Disabled ; 1 : Forward 2 : Reverse 3 : Three-wire control	Default: 1
P5-11	Multi-functional Input Terminal X2	4 : Multi-phase reference velocity 1 5 : Multi- phase reference velocity 2	Default: 2
P5-12	Multi-functional Input Terminal X3	6 : Multi- phase reference velocity 3	Default: 14
P5-13	Multi-functional Input Terminal X4	7 : JOG forward 8 : JOG reverse 9 : Increasing frequency	Default: 4
P5-14	Multi-functional Input Terminal X5 (CN1 needle base input)	10 : Decreasing frequency 11 : Acc-Dec time selection 1 12 : Acc-Dec time selection 2 13 : Acc-Dec pause	Default: 5
P5-15	Multi-functional Input Terminal X6	14 : External fault Input 15 : Fault reset	Reserved
P5-16	Multi-functional Input Terminal X7	16 : Freely stopping 17 : External count value input 18 : count clear	Reserved
P5-17	Multi-functional Input Terminal X8	19 : program run 20 : pause of program run	Reserved

- It's mainly applied to the setting of corresponding functions for digital multifunctional input terminals.

Table of Functions

Set value	Functions	Descriptions																																													
0	Disabled	Please set unused terminals to be invalid to avoid malfunction. It's applied to the setting of terminals which have no function; those additional terminals can be set as non-functional terminals to prevent converter from malfunctioning																																													
1	Forward	Set the forward and reverse of converter.																																													
2	Reverse	Please refer to description of P5-18 It's applied to the setting of terminals which control the running direction(forward/reverse) of converter; for detailed information, please refer to the instruction on Page5~18																																													
3	3-wire control	Please refer to description of P5-18 It's applied to the setting of three-wire control terminals (it's activated only when three-wire control is enabled); for detailed information, please refer to the instruction on Page5~18																																													
4	Multi-phase reference velocity 1	8 steps speed control can be realized by the combination of these four terminals. Eight kinds of speeds can be set through the combination of numbers which are decided by three terminals separately																																													
5	Multi-phase reference velocity 2	<table border="1"> <thead> <tr> <th>S₃</th> <th>S₂</th> <th>S₁</th> <th>Frequency</th> <th>Parameters</th> </tr> </thead> <tbody> <tr> <td>0</td> <td>0</td> <td>0</td> <td>Multi-phase reference velocity 0</td> <td>P0-03</td> </tr> <tr> <td>0</td> <td>0</td> <td>1</td> <td>Multi-phase reference velocity 1</td> <td>P8-01</td> </tr> <tr> <td>0</td> <td>1</td> <td>0</td> <td>Multi-phase reference velocity 2</td> <td>P8-02</td> </tr> <tr> <td>0</td> <td>1</td> <td>1</td> <td>Multi-phase reference velocity 3</td> <td>P8-03</td> </tr> <tr> <td>1</td> <td>0</td> <td>0</td> <td>Multi-phase reference velocity 4</td> <td>P8-04</td> </tr> <tr> <td>1</td> <td>0</td> <td>1</td> <td>Multi-phase reference velocity 5</td> <td>P8-05</td> </tr> <tr> <td>1</td> <td>1</td> <td>0</td> <td>Multi-phase reference velocity 6</td> <td>P8-06</td> </tr> <tr> <td>1</td> <td>1</td> <td>1</td> <td>Multi-phase reference velocity 7</td> <td>P8-07</td> </tr> </tbody> </table>	S ₃	S ₂	S ₁	Frequency	Parameters	0	0	0	Multi-phase reference velocity 0	P0-03	0	0	1	Multi-phase reference velocity 1	P8-01	0	1	0	Multi-phase reference velocity 2	P8-02	0	1	1	Multi-phase reference velocity 3	P8-03	1	0	0	Multi-phase reference velocity 4	P8-04	1	0	1	Multi-phase reference velocity 5	P8-05	1	1	0	Multi-phase reference velocity 6	P8-06	1	1	1	Multi-phase reference velocity 7	P8-07
S ₃	S ₂	S ₁	Frequency	Parameters																																											
0	0	0	Multi-phase reference velocity 0	P0-03																																											
0	0	1	Multi-phase reference velocity 1	P8-01																																											
0	1	0	Multi-phase reference velocity 2	P8-02																																											
0	1	1	Multi-phase reference velocity 3	P8-03																																											
1	0	0	Multi-phase reference velocity 4	P8-04																																											
1	0	1	Multi-phase reference velocity 5	P8-05																																											
1	1	0	Multi-phase reference velocity 6	P8-06																																											
1	1	1	Multi-phase reference velocity 7	P8-07																																											
6	Multi-phase reference velocity 3																																														
7	Forward jogging	Set the jog forward and jog reverse of converter																																													
8	Forward jogging	It's applied to the setting of terminals which control jogging direction (forward/reverse)																																													
9	Increasing frequency(Up)	The reference frequency of inverter can be adjusted by UP command and DOWN command.																																													

10	Decreasing Increasing (Down)	It's applied to the setting of external terminals which can change or modify the instructions to increase or decrease frequency. Upward or downward adjustment of frequency can be made through these two functions when frequency is set decided by number.																				
11	Acc-Dec time Option 1	4 groups of ACC/DEC time can be selected by the combination of these two terminals. Four kinds of Acc-Dec times can be set through the combination of numbers which are decided by two terminals separately																				
12	Acc-Dec time Option 2	<table border="1"> <thead> <tr> <th>Terminal 2</th> <th>Terminal 2</th> <th>Acc-Dec time options</th> <th>Parameters</th> </tr> </thead> <tbody> <tr> <td>0</td> <td>0</td> <td>Acc-Dec time 0</td> <td>P0-04, P0-05</td> </tr> <tr> <td>0</td> <td>1</td> <td>Acc-Dec time 1</td> <td>PA-00, PA-01</td> </tr> <tr> <td>1</td> <td>0</td> <td>Acc-Dec time 2</td> <td>PA-02, PA-03</td> </tr> <tr> <td>1</td> <td>1</td> <td>Acc-Dec time 3</td> <td>PA-04, PA-05</td> </tr> </tbody> </table>	Terminal 2	Terminal 2	Acc-Dec time options	Parameters	0	0	Acc-Dec time 0	P0-04, P0-05	0	1	Acc-Dec time 1	PA-00, PA-01	1	0	Acc-Dec time 2	PA-02, PA-03	1	1	Acc-Dec time 3	PA-04, PA-05
Terminal 2	Terminal 2	Acc-Dec time options	Parameters																			
0	0	Acc-Dec time 0	P0-04, P0-05																			
0	1	Acc-Dec time 1	PA-00, PA-01																			
1	0	Acc-Dec time 2	PA-02, PA-03																			
1	1	Acc-Dec time 3	PA-04, PA-05																			
13	Stop of Acc/Dec	When the terminal is valid, in ACC/DEC situation, it is running as current frequency. Acceleration or deceleration mode will be shut down when terminals are enabled; converter will be running in current frequency.																				
14	External fault Input	Stop the inverter and output a alarm when a fault occurs in a peripheral device Converter can detect fault and shut itself down automatically when external fault signal is received.																				
15	Fault reset	Resets faults that have occurred. It has the same function a RESET key It functions as RESET key functions, which can also be used to achieve remote control of fault reset.																				
16	Regular stopping	The inverter blocks the output immediately. The motor coasts to stop by its mechanical inertia. The process of stopping will not be affected by converter if there is no output signal sent to motor. It's applicable to any situation and the operation with large inertia load.																				
17	External count value input	Outer count input/pulse input Switching value of external count / pulse input																				
18	Counter reset	To counter the state cleared To reset the counter																				
19	Program run	Program is running according the terminal Program can be started by the terminal																				

20	Pause of program Run	Keep the converter in current running frequency when the terminal is valid, and the running time is not include in program running time. It can keep converter running in current frequency when terminals are enabled; during this period, running time is not count into the time of program run
20 -31	Reserved	Reserved

P5-18	Terminal control mode	0 : Two-wire control mode 1	Default: 0
		1 : Two-wire control mode 2	
		2 : Three-wire control mode 1	
		3 : Three-wire control mode 2	

• This parameter defines three different control modes of external terminals.

0: Two-wire control mode 1 is the most common two-wire mode, which can make directions conformed with each other; Forward or reverse direction will be decided by the instructions from FWD/REV terminals.

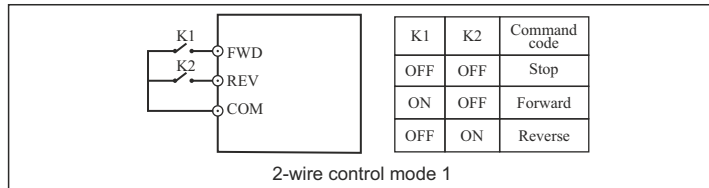

1: Two-wire control mode 2 can keep directions separated with each other; FWD terminal will be enabled while this mode is enabled; but direction will be decided by REV.

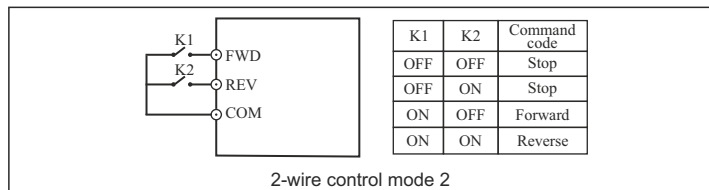

2: Rising edge of pulse and terminal SIn will be enabled while three-wire control mode 1 is enabled; direction is controlled by REV key; stop signal is controlled by input terminal SIn. The function of corresponding input terminal is defined by SIn terminal as No.3 function "three-wire control".

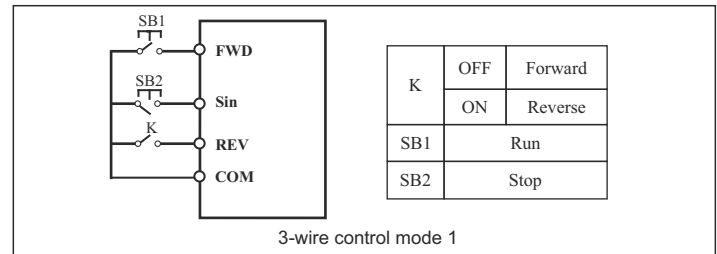

3: Rising edge of pulse and terminal SIn will be enabled while three-wire control mode 2 is enabled; run command is controlled by both REV of FWD keys which control the running direction at the same time; stop signal is generated by a on instant input terminal SIn. The function of corresponding input terminal is defined by SIn terminal as No.3 function "three-wire control".

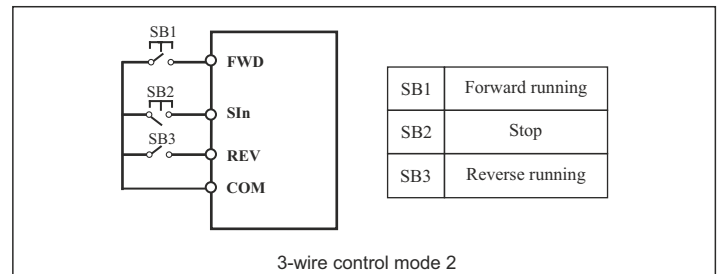

Tips: As for two-wire control mode, with the premise of the following two points, even control terminals FWD/REV remain enabled, converter will not be running any more after stop signal disappears:

- 1.FWD/REV terminals are enabled;
- 2.Converter is shut down because of stop signal generated by the other source; FWD/REV terminals must be enabled again if converter needs to be started.

P5-19	Terminal filtering mode	2ms ~ 100ms	Default: 10ms
--------------	-------------------------	-------------	---------------

- It's mainly used to set the sensitivity of terminals from X1 to X8. The parameter must be increased to improve the anti-jamming capability which can prevent DI terminals from being interfered, so that malfunctions can be reduced somehow; however, it may reduce the sensitivity of DI terminals.

P5-20	The range of the UP/DOWN increasing decline	0.0~50.0Hz	0.1
--------------	---	------------	-----

- When frequency increment/decrement with external terminal set, every time the frequency of the increase or decrease in value is decided by the P5-20.

P6: Output function parameters

P6-00	Y1 output options	0: Disabled 1: Running 2: Direction 3: Fault output 4: On standby 5: Frequency received 6: FDT 7: Upper limiting frequency received 8: Lower limiting frequency received 9: Setting count value received 10: Designated count value received	Default: 1
P6-01	Y2 output options		Default: 2
P6-02	Relay output options		Default: 3

Table of Output Functions

Set value	Functions	Descriptions
0	Disabled	Output terminals without any function
1	Running	When the converter is running, output the close signal It means that converter is running; closed signal is output.
2	Direction	On run reverse, output the close signal It indicates the running direction of converter; closed signal is output when it's running in reverse direction.
3	Fault output	When the converter is out of work, output the close signal Closed signal is output when it's malfunctioning.
4	On standby	Establish main circuit and control circuit power, the protection function of the converter is not change, and the converter is running, output the close signal Major loop and control circuit are established; protection function isn't enabled; converter is on standby; closed signal is output.
5	Frequency received	Please refer to the explanations of function code PA-11~13
6	FDT	
7	Upper limiting frequency received	ON: Running frequency reaches the value of P0-09 Signal "ON" is output when running frequency reaches upper limiting frequency
8	Lower frequency limiting received	ON: Running frequency reaches the value of P0-10 Signal "ON" is output when running frequency is equivalent to or lower than lower limiting frequency
9	Setting count value received	ON: the value of count reach the setting value of PA-14 Signal "ON" is output when count value reaches the value set by PA-14.
10	Designated count value received	ON: the value of count reach the setting value of PA-15 Signal "ON" is output when count value reaches the value set by PA-15.
11~15	Reserved	Reserved

P6-03	Ao1 options	0 : Operating frequency	Default: 0
		1 : Output current	
		2 : Bus voltage	
		3 :Output voltage	

- The standard range of analogue input current/voltage is 0~20mA/0~10V, which can be selected by Jumper 5. Output signals can be selected by the setting of this parameter, which correspond to output frequency or output current of converter.

Corresponding range of AO(0~10V/0~20mA) is as followed :

Set value	Functions	Descriptions
0	Running frequency	0~upper limiting frequency
1	Output current	0~double rated current
2	Bus voltage	0~double rated voltage
3	Output voltage	0~double rated voltage

P6-04	AO correction coefficient	0.0~250.0%	Default: 100.0%

- It's mainly not only applied to the correction of analogue output voltage but also used to adjust the range of analogue output voltage. Analog output voltage = Analogue output voltage × AO correction coefficient
- If the set value of parameter P6-03 is zero while the set value of parameter P6-04 is 100%, the corresponding AO of upper limiting frequency is +10V (20mA). AO correction coefficient can be increased properly to calibrate the analogue output voltage if practical AO is only 9.8V because of differences of circuit.

P6-05	Stop delay time setting	0~3000.0S	0

- When the inverter output signal when stop the machine open, until the P6-05, the output signal to shut down.

P7: PI control parameters

PI control is a common method to control the process. Output frequency can be adjusted by proportion & integral operations on the difference between the feedback signals of controlled variable and signals of objective variables.

P7-00	PI preset source options	0 : Digital keyboard	Default: 0
		1 : Panel potentiometer	
		2 : Analog channel AI1	
		3 : Analog channel AI2	

- This parameter functions if PI is chosen as frequency source, which means that the selection of P0-01 is option 4. The preset channel of objective variables for PI is determined by this parameter. The setting objective variables of PI are relative value; the percentage of the setting(100%) corresponds to the percentage of feedback signal(100%) in the controlled system. And operation is proceeded by the system according to the relative value(0~100%).

P7-01	PI set value	0.00~10.00V	Default: 0.00V
--------------	--------------	-------------	----------------

When P7-00 equals zero, PI set value will be set by this parameter.

P7-02	PI feedback source options	0 : Analog channel AI1	Default: 0
		1 : Analog channel AI2	

PI feedback channel is determined by this parameter.

P7-03	PI output characteristics options	0 : Positive	Default: 0
		1 : Negative	

Positive PI output characteristics: output frequency must be lowered to make it balance when the value of feedback signal is greater than PI set value, for example PI control on winding tension.

Negative PI output characteristics: output frequency must be increased to make it balance when the value of feedback signal is greater than PI set value, for example PI control on unwinding tension.

P7-04	Proportional gain (P)	0.0~10.0	Default: 1.0
P7-05	Integral time (I)	0.0~100.0s	Default: 0.1s

Proportional gain (P) determines the intensity of adjustment of PI regulator; the larger P value is, the higher the intensity of adjustment will be.

Integral time (I) determines the speed of integral regulation on the difference between PI feedback quantity and given quantity. The less integral time is, the higher the intensity of adjustment will be.

PI is the most common control method for process control; the function of each part is different from each other's. Please refer to the following brief introduction of operating principles and regulation methods:

Proportional gain (P): There will be proportional adjustment between output and deviation if there is difference between feedback value and set value; if deviation is constant, regulating variable is also constant. Proportional control responds to the change of feedback quickly; however, error control can't be proceeded only by proportional control. The greater proportional gain is, the smaller adjusting speed of system will be. But the proportional gain is excessive, it may cause vibration. The adjustment method is to extend the integral time and make system running only by proportional control; meanwhile, set value should be changed in order to observe its stable deviation (static error) between feedback signal and given quantity; if static error is in compatible with the change of given quantity, proportional gain can be increased continuously, for example increasing given quantity, or feedback quantity is always less than given quantity after system is stable; otherwise, please reduce it. The instruction above should be implemented repeatedly until deviation is optimized/minimized (tips: zero offset is almost impossible).

Integral time (I): when there is difference between feedback value and set value, regulating variable of output should be accumulated continuously; if the deviation can't be eliminated, the regulating variable should be increased continuously until there is no deviation. Deviation can be eliminated effectively by integral controller. However, overshoot may be caused repeatedly if the adjustment of integral controller is too much, which makes system unstable and even causes vibration. If vibration is caused by excessive integral action, following characteristics can be observed: oscillation of feedback signal on given quantity, expanding amplitude of oscillation, even vibration. The parameter of integral time should be adjusted generally from maximum value to minimum value so that the integral time can be changed gradually. Observation should be made on the effect on the system. Adjustment can't be stopped until the stable speed of system meets the requirements.

P7-06	Deviation limit of PI control	0.00~2.00	Default: 0.02
--------------	-------------------------------	-----------	---------------

Deviation limit of PI control defines the comparison between PI system output and maximum deviation value which is limited by closed-loop set value. As is shown in the graph, PI regulator is shut down while it's within deviation limit. The precision and stability of PI system can be improved by setting this function code properly.

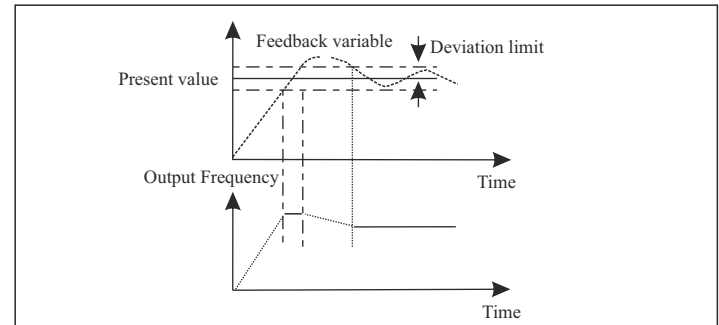

P7-07	Sampling period (T)	0.1~100.0s	Default: 0.02s
--------------	---------------------	------------	----------------

Sampling period (T) means sampling period of feedback quantity; operation is performed by regulator once every one sampling period. The longer sampling period is, the slower response will be.

P7-08	Detected value of feedback disconnection	0.00~5.00	Default: 0.0
P7-09	Time for detecting feedback disconnection	0.0~100.0s	Default: 10.0s

The feedback variable of PI can be always detected by system; if feedback variable is less than the detected value of feedback disconnection, system will consider feedback signal to be disconnected by default; if feedback variable is still less than the detected value of feedback disconnection while actual time is more than the time for detecting feedback disconnection, PIE can be detected and sent out by the system.

P7-12	Sleep time	0~3000s	600
P7-13	Dormancy pressure	0~10.00	0
P7-14	Dormancy frequency	0~50.0Hz	0
P7-15	Wake up the pressure	0~10.00	0

• Dormancy function description: when the back pressure value > dormancy pressure (P7-13), the frequency of running < dormancy frequency (P7-14). Waiting for the time of sleep (P7-12), began to sleep. When the pressure of the feedback < wake up pressure (P7-15), will cease to dormancy, inverter will run again.

1.1 Dormancy frequency (P7-14) Settings:

In under the condition of no water or gas, make the inverter running in the PID control mode (P0-01 = 0 or 1), start the inverter. Observation line pressure, slowly increase the frequency to the target according to user's requirements, record the current operating frequency after downtime. Set the dormant frequency (P7-14) just above the record frequency of 1-3 hz or so.

1.2 dormancy pressure (P7-13) set: dormancy pressure value slightly smaller than the target value.

1.3 when a dormant frequency P7-14 = 0 or resting pressure P7-13 = 0, don't start the sleep function.

P8: Simple PLC and Multispeed Parameters

P8-00	Program run mode	0 : Disabled 1 : Program stop after one-cycle running 2 : Program operates as last program runs after one-cycle running 3 : Circulatory running of program	Default: 0
--------------	------------------	---	------------

0: Disabled

1: Program stop after one-cycle running

Converter will be stopped automatically after one-cycle running; only after run command is entered again will it be started.

2: Program operates as last program runs after one-cycle running

The operating frequency and direction in the last program will be remained to the end after one-cycle running.

3: Circulatory running of program

The next cycle of operation will be proceeded by converter automatically right after one-cycle running; system will not be shut down until stop command is received.

indiameters.in

P8-01	First phase speed	Lower limiting frequency ~ Upper limiting frequency	Default: 11.0Hz
P8-02	Second phase speed	Lower limiting frequency ~ Upper limiting frequency	Default: 12.0Hz
P8-03	Third phase speed	Lower limiting frequency ~ Upper limiting frequency	Default: 13.0Hz
P8-04	Forth phase speed	Lower limiting frequency ~ Upper limiting frequency	Default: 14.0Hz
P8-05	Fifth phase speed	Lower limiting frequency ~ Upper limiting frequency	Default: 15.0Hz
P8-06	Sixth phase speed	Lower limiting frequency ~ Upper limiting frequency	Default: 16.0Hz
P8-07	Seventh phase speed	Lower limiting frequency ~ Upper limiting frequency	Default: 17.0Hz

These parameters above are mainly applied to the setting of seven different phase speeds; principal frequency is still controlled by parameter P0-03.

P8-08	Runtime of principal frequency	0~6400.0	Default: 0.0
P8-09	First phase time	0~6400.0	Default: 0.0
P8-10	Second phase time	0~6400.0	Default: 0.0
P8-11	Third phase time	0~6400.0	Default: 0.0
P8-12	Forth phase time	0~6400.0	Default: 0.0
P8-13	Fifth phase time	0~6400.0	Default: 0.0
P8-14	Sixth phase time	0~6400.0	Default: 0.0
P8-15	Seventh phase time	0~6400.0	Default: 0.0
P8-16	Time unit of multi-velocity	0 : second 1 : minute 2 : hour	Default: 0

indiameters.in

These parameters from P8-08 to P8-15 are mainly applied to the setting of run time for the velocity of each phase. Time unit can be preset by parameter P8-16.

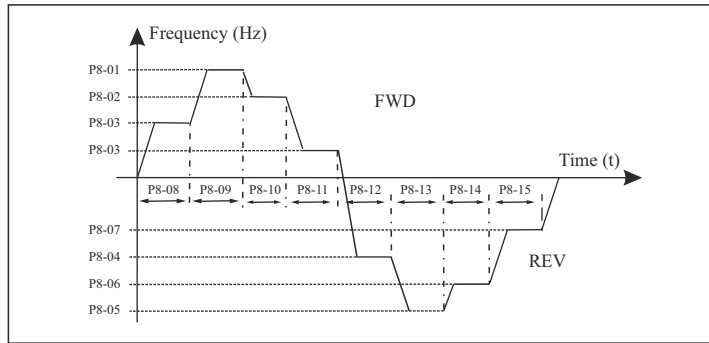

P8-17	Running directions of programs	0~255 BIT 0~7 indicates 0~7 directions (0: Forward 1: Reverse)	Default: 0

It's mainly applied to the setting of running directions for each program, which is preset by binary mode (8 bit). Parameter can be entered only after the binary value is converted into decimal value. Take the following settings for example:

Weighted value	2 ⁷	2 ⁶	2 ⁵	2 ⁴	2 ³	2 ²	2 ¹	2 ⁰	0 : Forward
Binary set value	0	1	0	0	1	0	1	0	1 : Reverse
BIT	7	6	5	4	3	2	1	0	

- Running directions of Principle frequency: FWD
- Running directions of first phase: REV
- Running directions of second phase: FWD
- Running directions of third phase: REV
- Running directions of forth phase: FWD
- Running directions of fifth phase: FWD
- Running directions of sixth phase: REV
- Running directions of seventh phase: FWD

Parameter values = $\text{bit}7 \times 2^7 + \text{bit}6 \times 2^6 + \text{bit}5 \times 2^5 + \text{bit}4 \times 2^4 + \text{bit}3 \times 2^3 + \text{bit}2 \times 2^2 + \text{bit}1 \times 2^1 + \text{bit}0 \times 2^0$
 $= 0 \times 2^7 + 1 \times 2^6 + 0 \times 2^5 + 0 \times 2^4 + 1 \times 2^3 + 0 \times 2^2 + 1 \times 2^1 + 0 \times 2^0$
 $= 0 + 64 + 0 + 0 + 8 + 0 + 2 + 0$
 $= 74$

Namely (01001010)₂ = (74)₁₀
 Hence P8-17 should be set as 74

P8-18	Timing for each program's Acc-Dec	0~65535 BIT 0~15 indicates the ACC/DEC time of 0~7	Default: 0

It's mainly applied to the setting of Acc/Dec time for each program, which is preset by binary mode (16 bit). Parameter can be entered only after the binary value is converted into decimal value.

Take the following settings for example:

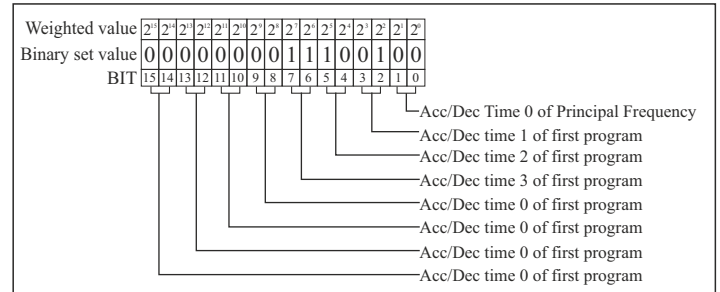

Parameter values = $(0000000011100100)_2 = (228)_{10}$
 Hence the P8-18 should be set as 228

P9 : Protection Function parameters

P9-00	Options for overload protection	0 : Disabled 1 : Enabled	Default: 0
P9-01	Critical point of overload protection	50~120%	Default: 110%

These two parameters are mainly applied to the setting of real-time relay protection of load motor. Effective thermal protection of motor can be achieved by setting this parameter correctly when rated current of motor is not matched with rated current of converter. Critical point of overload protection (motor) = (allowed max. load current / rated current of motor) * 100%

P9-02	Overload protection	0 : Disabled 1 : Enabled	Default: 1
P9-03	Critical point of Over voltage	110.0~150.0%	Default: 118

Due to the influence of inertia load, actual droop rate of motor's rotational speed may be lower than droop rate of output frequency while converter is decelerating; meanwhile, electrodes may feedback electric energy to converter, which may raise the bus voltage of converter. If no action is taken in time, stripping may be caused by over voltage of busbar.

Over voltage protection function will be enabled so that the decreasing output frequency of converter can be slowed down if bus voltage detected by converter while running exceeds the critical point of over voltage defined by parameter P9-03(in comparison with standard bus voltage); if it's detected that the bus voltage is lower than the critical point, converter will continue to decelerate again.

P9-04	Over current protection	0 : Disabled 1 : Enabled	Default: 1
P9-05	Critical point of over-current	100~180%	Default: 180

Because of excessive load, actual rate of rotational speed rise of motor may be lower than the rate of output frequency rise while converter is decelerating; if no action is taken in time, stripping may be caused by over current.

Over-current protection function will be enabled so that increasing output frequency of converter can be slowed down if bus current detected by converter while running exceeds the critical point of over current defined by parameter P9-05; if it's detected that output current is lower than the critical point, converter will continue to accelerate again.

P9-06	Phase-failure protection of input	0 : Disabled 1 : Enabled	Default: 0
P9-07	Phase-failure protection of output	0 : Disabled 1 : Enabled	Default: 0

Phase-failure protection of input: options are selected to enable or disable phase-failure protection for input Phase-failure protection of output: options are selected to enable or disable phase-failure protection for output

P9-08	Latest fault information	0~20	
P9-09	Latest fault information	0~20	
P9-10	Last two fault messages	0~20	

These parameters above can't be modified or changed; they are read-only.

The latest three fault types can be recorded by converter:

Zero means there is no malfunction

1~20 stands for twenty different malfunctions; for detailed information, please refer to Chapter 7 "Fault Correcting".

P9-11	Operating frequency of latest fault		
P9-12	Output current of latest fault		
P9-13	Bus voltage of latest fault		
P9-14	Input state of latest fault		
P9-15	Output state of latest fault		

These parameters above can't be modified or changed; they are read-only. Status information about the latest malfunctions can be recorded by converter, including its operating frequency, current and voltage.

P9-16	Fault since the reset function	0: invalid 1: under-voltage fault automatic reset(unlimited) 2~20: fault self-recovery alarm	0
-------	--------------------------------	--	---

- **Please set this function carefully, to ensure that the fault occurs again after the operation of the safety of person or equipment.**
- After 2 ~ 20: frequency converter fault alarm automatically reset the number of times. Under-voltage alarm reset is always valid.

Parameters of PA Enhancements

PA-00	Acceleration time 1	0.0~3600.0s	Default: 20.0s
PA-01	Deceleration time 1	0.0~3600.0s	Default: 20.0s
PA-02	Acceleration time 2	0.0~3600.0s	Default: 20.0s
PA-03	Deceleration time 2	0.0~3600.0s	Default: 20.0s
PA-04	Acceleration time 3	0.0~3600.0s	Default: 20.0s
PA-05	Deceleration time 3	0.0~3600.0s	Default: 20.0s

Acc/Dec times are available to be selected, included three kinds of Acc/Dec times above, P0-04 and P0-05. They are all the same in definition; for detailed explanations, please refer to P0 series.

Acc/Dec time 0~3 can be selected through different combinations of multi-functional digital input terminals.

PA-06	Jog acceleration time	0.0~3600.0s	Default: 5.0s
PA-07	Jog deceleration time	0.0~3600.0s	Default: 5.0s

These two parameters above are applied to the definition of Acc/Dec time for jogging which can be started or stopped through direct starting or stop by decelerating.

Jog acceleration time indicates the time for converter to accelerate from 0 Hz to maximum frequency (P0-08).

Jog deceleration time indicates the time for converter to decelerate from maximum frequency (P0-08) to 0 Hz.

PA-08	Hopping frequency 1	0.0~Upper limiting frequency (P0-09)	Default: 0.0Hz
PA-09	Hopping frequency 2	0.0~Upper limiting frequency (P0-09)	Default: 0.0Hz
PA-10	Amplitude of Hopping frequency	0.0~Upper limiting frequency (P0-09)	Default: 0.0Hz

Actual operating frequency will be held at the boundary of hopping frequency which is closed to preset frequency when preset frequency is within the range of hopping frequency.

Converter can be kept away from the resonance point of load by the setting of hopping frequency. Two hopping points of frequency are set for this converter; if both of these two points are set as zero, this function will be disabled.

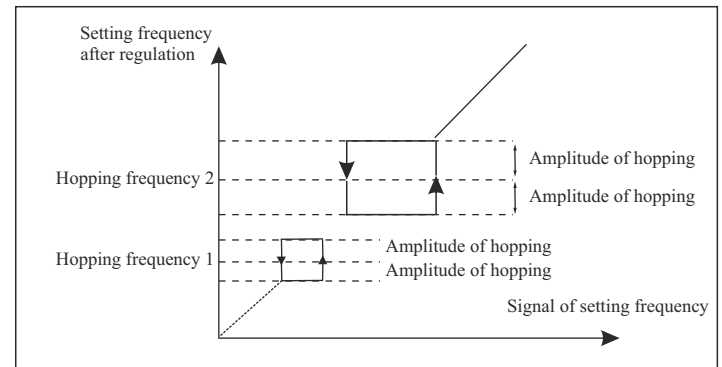

PA-11	FDT level value	0.0~Upper limiting frequency (P0-09)	Default: 0.0Hz
PA-12	FDT lagged value	0.0~FDT level value (PA-11)	Default: 0.0Hz

These two parameters above are mainly applied to the setting of the detected value of output frequency (PA-11) as well as lagged value obtained after output is enabled.

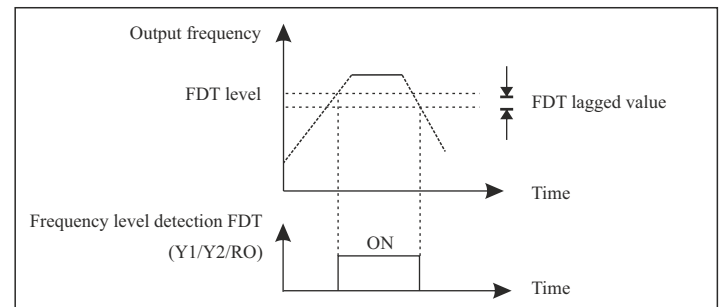

PA-13	Amplitude of detected frequency FAR	0.0~Upper limiting frequency (P0-09)	Default: 0.0Hz
-------	-------------------------------------	--------------------------------------	----------------

- It's mainly applied to the setting of amplitude detection for detected frequency.

Please refer to the following graph:

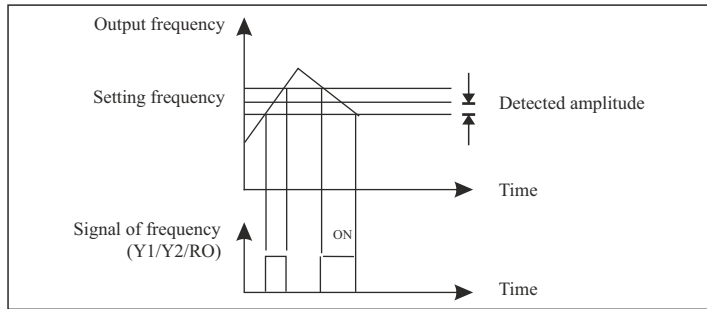

PA-14	Setting count value	1~65535	Default: 10
PA-15	Specified count value	1~65535	Default: 10

Counts of pulse signal or switching signal can be input by the counter which is installed in the multi-functional DI terminal.

When count value reaches up to preset count value, signal will be output by DO terminal to prove that preset count value is reached.

When count value reaches up to specified count value, signal will be output by DO terminal to prove that specified count value is reached. Counter will not stop until it reaches up to "setting count value"

Specified count value PA-15 must be no more than setting count value PA-14.

PA-16	Underclocking function for overload	0 : Disabled 1 : Enabled	Default: 1
--------------	-------------------------------------	-----------------------------	------------

Converter's current will also be increased as abnormal load transient boosts instantaneously; if no action is taken in time, stripping may be caused by over current.

Under clocking function for overload: if instantaneous current is increased up to the maximum, output frequency of converter must be decreased properly to restrain current from being increased so that converter can be prevented from stripping caused by instantaneous overload.

FAULT CORRECTING

7-1 Malfunction and Solutions

Fault indication	Code	Fault type	Fault cause	Solutions
LU	3	Under voltage	Abnormal power supply or loose contact	Input voltage and wiring should be checked
OU	4	Over voltage	1. Input voltage 2. Rapid deceleration 3. Excessive inertia load	1. Check input voltage 2. Increase deceleration time 3. Select dynamic braking components
OC	6	Over current	1. Mismatch of capacity 2. Low voltage of grid 3. Rapid acceleration and deceleration 4. High torque of inertia load 5. Abnormal load	1. Select converter with large capacity 2. Check power source and wiring 3. Increase Acc-Dec time 4. Select applicable braking parts 5. Detect and reduce load changing
OL	5	Overload (Converter)	1. Please refer to fault cause of over current (OC) 2. Overload (motor) 3. Inapplicable setting of V/F curve	1. Please refer to solutions for over current(OC) 2. Reduce motor load 3. Reset parameters
OL1	15	Overload (Motor)	1. Low voltage of grid 2. Excessive motor stalling or load changing 3. Inapplicable setting of V/F curve, rated current or critical point of overload protection	1. check the voltage of grid 2. check motor load 3. reset parameters

Fault indication	Code	Fault type	Fault cause	Solutions
SC	9	Short-circuit output	<ol style="list-style-type: none"> 1. please refer to fault cause of over current (OC) 2. short circuit of output terminal (U,V,W) or earth terminal 3. loose plug-in units or wiring of control panel 4. damages of power module or other parts 	<ol style="list-style-type: none"> 1. Please refer to solutions for over current(OC) 2. Check the state of insulation (motor & cable) 3. Check the connection of plug-in units 4. Seek technical support for damages
SPI	7	Input Failure	default phase of power source R,S,T	<ol style="list-style-type: none"> 1. Check power source and its voltage 2. Check the connection of power line
SPO	8	Output failure	<ol style="list-style-type: none"> 1. Default phase of output terminals U, V, W 2. Unsymmetrical three-phase load 	<ol style="list-style-type: none"> 1. Check the connection of output line 2. Check motor and its cables
OH	13	Overheat	<ol style="list-style-type: none"> 1. High ambient temperature 2. Obstruction of ventilation duct or damage of cooling fan 3. Excessive motor load 	<ol style="list-style-type: none"> 1. Lower the ambient temperature 2. Clear the ventilation duct and replace the cooling fan 3. Reduce motor load or carrier frequency
PIE	12	PI Fault	No detection of PI feedback signal for a certain time	Check on PI feedback signal and connection
EF	11	External fault	Input terminal for external fault signal is enabled	Check the input of external devices

Fault indication	Code	Fault type	Fault cause	Solutions
EEP	1	EEPROM fault	<ol style="list-style-type: none"> 1. R/W errors of parameter 2. Damage of EEPROM 	<ol style="list-style-type: none"> 1. Factory reset 2. Seek technical support for damages
NCE	16	Contactor fault	<ol style="list-style-type: none"> 1. low voltage of grid 2. damage of contactor 3. the other damaged circuit 	<ol style="list-style-type: none"> 1. Check the voltage of grid 2. Replace the contactor of major loop 3. Seek technical support for damages
OPSE	10	System failure	Severe interface external factors, e.g. noise	install additional filter or seek technical support for damages
CF	20	The current detecting signal failure	<ol style="list-style-type: none"> 1. The current sensor is damaged 2. Signal lines, poor contact 3. Other line fault 	<ol style="list-style-type: none"> 1. Change the current sensor 2. Check the Signal line 3. Seeking services

7-2 Common Faults and Processing Schemes

If the following situations are met during the application of converter; please refer to the instructions below:

- **No information display after power on**

Please confirm whether the voltage of power source is compatible with the rated voltage of converter.

Please check whether three-phase rectifier bridge is in good condition; if it's damaged, please seek for technical support.

Please check if power indicator is on or not; if it's off, malfunction is mainly caused by abnormal rectifier and buffer resistance; if it's on, malfunction is mainly caused by switching power supply. Meanwhile, please seek for technical support.

- **Air switch of power source trips when power on**

Please check whether power source is grounded or short-circuited; please solve it accordingly.

Please check whether rectifier bridge is burned; if it's damaged, please seek for technical support.

- **Motor doesn't start running after converter is started**

Please check whether there is three-phase symmetrical output among U, V, W. If there is, motor or its circuit is damaged mostly; or stalling may be caused by mechanical problem. please solve it accordingly.

If three-phase output is unsymmetrical, then driver board or output module of converter may be damaged. Please seek for technical support.

If there is output voltage, then driver board or output module may also be damaged.

Please also seek for technical support.

- **Air switch of power source trips while running**

Please check whether output modules between phase and phase are short-circuited; if there is short circuit, please seek for technical support.

Please check whether motor lines are short-circuited or grounded; if they are, please solve it accordingly.

If stripping take places sometimes, not regularly; and there is a long distance between motor and converter, please take the installation of additional AC reactor into consideration.

MAINTENANCE

Only the qualified engineer is allowed to conduct maintenance for converter; please pay attention to the following precautions:

- Maintenance must be conducted by qualified engineer in specified way;
- Only when converter is shut down for 5 minutes can maintenance be conducted;
- Do not touch the components on the PCB directly; otherwise, components can be damaged by static easily.
- Make sure that all the screws are fastened after the maintenance.

8-1 Daily Maintenance and Upkeep

Affected by environmental conditions(e.g. temperature, humidity or smog) and aging of internal components, converter may malfunction. Therefore, daily inspection and maintenance on converter must conducted during the process of storage and application. For the detailed information of daily inspection and maintenance, please refer to the following table:

Items	Examination period		Check points	Criterion and Maintenance
	non-periodical	regular		
Environmental conditions	√		1. Temperature humidity 2. Dust & mist 3. Gas &	1. Temperature <40°C, humidity < 90%, no frost 2. No odor, No flammable or explosive gas
Cooling system		√	1. Installation environment 2. Built-in fan	1. Good ventilation, no obstruction of ventilation duct 2. Normal operation of built-in fan, no abnormal noise
Converter	√		1. Vibration temperature rise 2. Noise 3. Dust or impurity 4. lead and terminals	1. Stable vibration, normal blast temperature 2. No abnormal noise or odor 3. Remove dust by dry compressed air 4. No loose screws

Items	Examination period		Check points	Criterion and Maintenance
	non-periodical	regular		
Motor	√		1. Vibration and temperature rise 2. Noise	1. Stable operation and normal temperature 2. No malfunction or abnormal noise
I/O parameters	√		1. Input voltage 2. Output current	1. Input voltage is within specified range 2. Output current is lower than rated value

8-2 Inspection and replacement of damageable parts

As for some of internal components, abrasion or performance degradation may be caused during use. To ensure stable and reliable operation, preventive maintenance on converter must be conducted. If necessary, please replace them:

Fan must be replaced after more than 20,000 hours' running. Electrolytic capacitor must be replaced after 30,000~40,000 hours' running

8-3 Storage

This product can't be taken out from box until it's about to be installed. To ensure that it's still valid for warranty and available for maintenance in the future during the period of storage, please pay attention to the following points:

- Converter must be stored in a dry place where there is no dust;
- Ambient temperature must be within the range between -20°C and 60°C;
- Relative humidity must be within the range between 0% and 95%; no condensation is permitted;
- It must be protected from caustic gas or liquid;
- It must be packed properly and put on the shelf or desk.

8-4 Product Warranty

Any of the following situations will be our company's responsibility, which will be considered and guaranteed:

- The warranty period for this product is 18 months but only 12 months for final buyer. During the period, any damage or fault without any wrong operation will be our responsibility to fix, which is free of charge. Maintenance fee will be charged accordingly if warranty expires.
- Regarding the faults caused by the following points, extra fee will need to be charged as service fee:
 1. Fault caused by faulty operation which is not in conformity with manual or specification
 2. Fault caused by unauthorized maintenance modification;
 3. Damage caused during the transportation or improper safekeeping;
 4. Fault caused by misuse failure
 5. As for the damages caused by fire, salt corrosion, gaseous corrosion, earthquake, storm, flood, thunder strike, abnormal voltage and other irresistible factor, despite of the expiration of warranty, any compensable maintenance service will be provided by our company for good.

COMMUNICATION PROTOCOL

Modbus protocol is the main communication method applied in FD100 & FD200 series converter with RS485 interfaces, which is compliant with International Communication Standards. Centralized control can be implemented by PC/PLC as well as superior controller to adapt specific requirements for applications, including setting of control command, operating frequency, modification of parameters for relevant function code, monitoring of operating status or malfunction.

9.1 Protocol Content

Modbus, also known as serial communication protocol, has defined its frames and format during the asynchronous transmission, including the format of polling to the host, broadcast frames and response frames to slave controller. The frames generated by the host included slave address/broadcast address, executive command, data & error correction; and the response of the slave controller has the similar frames as the host, including confirmation of instructions, data feedback and error correction. If any error happens when the slave controller receives the frames, or any instruction requested by the host can't be done, it will generate a malfunction frame and send feedback to the host.

9.1.1 Application mode

FD100 & FD200 series converter is compatible with control network equipped with RS485 bus which has single host & multiple slave controllers.

9.1.2 Bus Structure

1. Hardware interface
RS485 hardware interface
2. Transmission mode
Serial & asynchronous, half-duplex transmission -TXD and RXD can be done at the same time by either the host or the slave controller separately, which means there are only one sender and one receiver at a time. Data will be transmitted frame by frame in the format of message during the serial & asynchronous communication.
3. System with single host & multiple slave controllers
The range of slave address should be 1~127; the number Zero stands for broadcast communication address. Every single slave address on the Internet is unique, which is the foundation of Modbus serial communication.

9.2 Protocol Introductions

The protocol of FD200 Series Converter is a kind of serial & asynchronous communication protocol with principal and subordinate Modbus; there is only one device(host) could set up protocol (named "query /command"), and the other devices(slave) can only response to the host's "query /command" by sending data, or issue commands/instructions according to the "query /command" from the host. The host herein mainly refers to personal computer, industrial control facility or Programmable Logic Controller (PLC); and the slave herein mainly refers to FD200 Series Converter or the other control facilities with similar/same communication protocol. The host can not only communicate with a certain slave controller independently but also send broadcast message to all the slave controllers. As to any independent access to the host's "query /command", a message (called response) must be sent out from the slave controller; however, regarding the broadcast message issued by the host, it's not necessary for the slave controller to send feedback to the host.

9.3 Frame Structure

The data format of Modbus communication protocol applied in the FD200 Series Converter is RTU mode (Remote Terminal Unit)

In the RTU mode, the format of each byte is as follow: encoding system -8-bit binary system, there are two hexadecimal characters included in every 8-bit frame (hexadecimal characters include 0~9 & A~F). The transmission of new frame will always be restarted with a interval of 3.5 bytes transmission time. When it's connected with the Internet of which transmission rate is calculated by Baud rate, 3.5-byte transmission time is easy to be controlled. The data fields of transmission will be sent in sequence as below: slave address - operating command code - data & CRC check word; and transmission byte of each field are hexadecimal (0~9, A~F). The networking devices will always monitor the operation of communication bus; when the first domain (address information) is received, it will be confirmed again by each networking device; when the transmission of last byte is done, there will be a interval of 3.5 bytes transmission time to identify the end of this frame. After that, transmission of new frame will be started again.

Frame Format of RTU Data					
MODBUS Message					
Initiate: a interval of at least 3.5 bytes	Slave address	Function code	Data	Verification	Terminate: a interval of at least 3.5 bytes

A frame message must be transmitted in a consecutive data stream; if the interval is more than 1.5-byte transmission time before transmission of the whole frame is finished, those incomplete messages will be cleared by the receiver which will take the next byte as part of address field of new frame by mistake; likewise, if the interval is less than 3.5-byte transmission time, the receiver will identify it as the extension of last frame. Because of disorder of frames, CRC value will be incorrect, which may result in malfunction.

Standard Structure of RUT Frame :

Frame header	T1-T2-T3-T4 (3.5-byte transmission time)
Slave address field	Communication address: 0~147(decimal system) / (Zero stands for broadcast communication address)
Function domain (CMD)	0x03: reading parameters of slave controller 0x06: programming parameters of slave controller
Data field ENTER (N-1) ... ENTER (0)	2*N-byte data is not only the main content of communication but also the core of data exchange during the communication.
Checksum	Estimated value: CRC value (16BIT)
Frame ending	T1-T2-T3-T4 (3.5-byte transmission time)

9.4 Command code & data description

9.4.1 Format of No.1 address for Setting as follows, setting frequency 50Hz (PO-03)

Superior host command:

Frame header	3.5-byte interval
Address	0x01
Function code	0x06
Register address	0x0003
Register information	0x01F4
Checksum	0x79DD
END	3.5-byte interval

Converter's response:

Frame header	3.5-byte interval
Address	0x01
Function code	0x06
Register address	0x0003
Register information	0x01F4
Checksum	0x79DD
END	3.5-byte interval

9.4.2 Format of No.1 address for reading as follows, setting frequency (PO-03)

Note: register number must be one only when reading

Superior host command:

Frame header	3.5-byte interval
Address	0x01
Function code	0x03
Register address	0x0003
Register information	0x0001
Checksum	0x740A
END	3.5-byte interval

Converter's response:

Frame header	3.5-byte interval
Address	0x01
Function code	0x03
Register address	0x02
Register information	0x01F4
Checksum	0xB853
END	3.5-byte interval

9.4.3 Frame format of response error as follows, setting frequency 60Hz (PO-03)

Type of error:

01H - Data address overrun

02H - Number of data overrun & read-in data content exceeding bounds (ceiling & floor)

03H - Operating, no read-in data are permitted

Superior host command:

Frame header	3.5-byte interval
Address	0x01
Function code	0x06
Register address	0x0003
Register information	0x0258
Checksum	0x7950
END	3.5-byte interval

Converter's response:

Frame header	3.5-byte interval
Address	0x01
Function code	0x86
Error code	0x02
Checksum	0xC3A1
END	3.5-byte interval

9.4.4 CRC Mode

RTU frame format is mainly applied to CRC (Cyclical Redundancy Check), error detecting field based on CRC is included in the message. CRC domain can detect all the information of message, which is two bytes with 16-bit binary value included. It will be added into the message after the calculation of transmission devices. The receiver will recalculate the CRC receiving the message, and compare it with the values in the CRC domain received by devices; if the CRC value is not equivalent to another one, it proves that there is error in the transmission.

CRC will write 0xFFFF in superior host, and call a program to process the consecutive 8 bytes in the message as well as the values in the register. Only 8-bit data of each character is valid to CRC, the others are all invalid, including start bit, stop bit and parity check bit.

During the operation of CRC, each of 8-bit character is exclusive(XOR) with register content separately; result will be inclined to the least significant bit(LSB) while the most significant bit will be filled with Zero. LSB will be extracted from the data for checking; if LSB is one, register will be exclusive(XOR) with preset value separately; if LSB is zero, calculation will not be conducted. This instruction of process will repeat for 8 times; when it comes to the last bit (8th bit), the next 8-bit bytes will be exclusive(XOR) with register value again. The final value in the register is the CRC value after the calculations of all the bytes in the message.

When CRC is added into the message, lower byte will be added first, then the high byte. The simple function of CRC is as follows:

```
unsigned int crc_chk_value (unsigned char *data_value, unsigned char length) {
    unsigned int crc_value=0xFFFF;
    int i;
    while (length--) {
        crc_value^=*data_value++;
        for (i=0;i<8;i++) {
            if (crc_value&0x0001)
            {
                crc_value= (crc_value>>1)
            }
            else
            {
                crc_value= (crc_value>>1)
            }
        }
    }
    return (crc_value) ;
}
```

9.5 Read-write rules of parameter address for function code

1. Descriptions of the other functions' address

Parameters address monitoring:

Register address	Address S/N	Data Description	Register address	Address S/N	Data Description
0xDC	220	Setting frequency	0xE6	230	PI preset value
0xDD	221	Output frequency	0xE7	231	PI feedback value
0xDE	222	Output Current	0xE8	232	Run time
0xDF	223	Busbar voltage	0xE9	233	Input interface
0xE0	224	Motor speed	0xEA	234	Output interface
0xE1	225	Percentage of current	0xEB	235	Rated power
0xE2	226	IGBT temperature	0xEC	236	Compensation Frequency
0xE3	227	Output voltage	0xED	237	Compensation voltage
0xE4	228	Output power	0xEE	238	Phase angle
0xE5	229	Count value	0xEF	239	Load factors

Control command

(valid when P0-02 is changed into 3)

Register address	Address S/N	Data Description
0xC8	200	1 : FWD run
		2 : FWD jogging
		5 : REV run
		6 : REV jogging
		8 : Stop
		16 : Regular stopping
		32 : Reset

Status of Converter

Register address	Address S/N	Data Description
0xF0	240	0 : Operating
		1 : FWD running
		2 : REV running
		6 : Malfunctioning

Fault address

Register address	Address S/N	Data Description	
0xF1	241	1: Storage fault	10: System fault
		3: Undervoltage	11: External fault
		4: Overvoltage	12: PI fault
		5: Overload	13: Overtemperature
		6: Overcurrent	14: Overcurrent
		7: Input default phase	15: Motor Overload
		8: Output default phase	16: Contactor OFF
		9: Output short circuit	20: Signal failure of current detection

9.6 Parameter description of communication

Factory default	Baud rate	9600
-----------------	-----------	------

The parameter above is used to set transmission rate of the data between superior controller and converter.

Note: the Baud rate of superior controller and converter should be the same; otherwise, communication cannot be conducted.

Data format	Factory default	No checking: 8-N-1
-------------	-----------------	--------------------

The data format of superior controller and converter should be the same; otherwise, communication cannot be conducted.

P0-15	Factory default	Factory default	1
	Setting range	0-127 (Zero stands for broadcast address)	

The data format of superior controller and converter should be the same; otherwise, communication cannot be conducted.

APPENDIX

10-1 List of braking resistor

If controlled motor decelerates too fast, or load jittering of motor is too fast while converter is running, its electromotive force will charge the internal capacitors of converter through converter's reverse function, which will rise the voltage of power module and damage converter. However, this will be restrained by converter's internal control according to the condition of loading; additional braking resistor needs to be installed externally to release the power in time when braking performance doesn't meet customers' requirements. External braking resistor works by consuming energy which will be consumed completely by power braking resistor; therefore, power and resistance of braking resistor must be applicable and effective. Braking resistors whose power and resistance value are as followed are recommended to be applied to this converter. According to the condition of loading, value can be changed properly; but it must be no less than the minimum of this converter

For FD100

Converter Power	Recommended resistance	Minimum resistance
FD100-1-0-10-C-CE	150W 400Ω	260Ω
FD100-1-0-20-C-CE	200W 300Ω	200Ω
FD100-1-0-30-C-CE	250W 200Ω	150Ω

For FD200

Converter Power	Recommended resistance	Minimum resistance
FD200-3-075-C-CE	500W 90Ω	60Ω
FD200-3-100-C-CE	800W 60Ω	47Ω
FD200-3-150-C-CE	1000W 47Ω	36Ω
FD200-3-200-C-CE	1500W 36Ω	27Ω
FD200-3-250-C-CE FD200-3-1000-C-CE	According to the requirements of brake units and recommended to choose	

Due to the energy consumption of braking resistor, a mass of heat may be generated if it keeps braking frequently; therefore, safety and Inflammability of the surrounding must be taken into consideration

10.2.1 For VFD100

Rated Power kW	0.7	1.5	2.2	0.7	1.5	2.2	
Output current A	5	7	11	2.5	3.7	5.1	
Rated voltage V	Single-phase 220V			Three-Phase 415V			

Specifications

Power supply	Rated input voltage/frequency	Single Phase 220V 50Hz/60Hz, 3 Phase 415V 50Hz/60Hz.
	Permissible voltage fluctuation	187V to 253V for 1 phase & 320 to 460V for 3 Phase
	Permissible frequency fluctuation	±5%
Control Characteristic	Control mode	Space Vector SVPWM and Flux Vector Control
	Frequency Control range	0.1 ~ 400 Hz.
	Frequency Accuracy	Digital setting 0.01%, Analog instruction 0.1% (Max frequency)
	Frequency resolution	Digital instruction 0.1Hz, Analog instruction 0.1 Hz.
	Accelerated/decelerate time	0.0 ~ 3600 Sec. Four accelerate/decelerate time settings available
	Multi Speed running	Built-in program
	Built-in PI	Easy to set up a simple Automatic control system
	Built-in Counter	Automatically Controlled Production line can be achieved
	Overload Capacity	G Type - 150% rated current for 1 min. P type - 120% rated current for 1 min
	Braking torque	About 20% (with brake resistor is about 150%)
	V/F mode	3 preset V/F mode and V/F program
	Automatic Energy Saving Operation	Changes the V/F curve according to the load to save energy
	Automatic Voltage Regulation	Regulates the voltage automatically whenever there is a change in grid voltage

Operation Function	Operation Commands	Keypad and External terminals
	Frequency Setting	Digital setting, Analog Voltage setting, Analog Current setting
	Input Signal	Forward/Reverse, Jogging selection, Multi Speed Control, Regular Stopping
	Output signal	Fault Alarm Output (250V/2A Contact), Open Collector Output
Protection Functions		Over Current, Over Voltage, Under Voltage, Over heat, Overload, Phase loss
Display		Parameters setting, Running status and Fault display
Operating conditions	Operating environment	Temperature: 10 ~ 40 Degree C, Humidity: < 90%, No condensation, IP20
	Operations Area	Indoor, <1000m altitude above sea level
	Storage Temperature	-20 ~ +60 Degree C
	Vibration	<5.9 m/s ² (0.6g)

10.2.2 For VFD200 Series

Rated Power kW	0.7	1.5	2.2	0.7	1.5	2.2	4	5.5	7.5	11	15	18.5	22	30
Output current A	4.8	7	5.1	2.5	3.7	5.5	9	13	17	25	32	38	45	60
Rated voltage V	Single-phase 220V			Three-phase 415V										

Rated Power kW	37	45	55	75	90	110	132	160	185	200	220	250	280	315
Output current A	75	90	110	150	176	210	250	300	340	380	420	470	520	585
Rated voltage V	Three-phase 415V													

Specifications

Power supply	Rated input voltage/ frequency	3 phase 415V 50Hz/60 Hz.
	Permissible voltage fluctuation	320 to 460V for 3 Phase
	Permissible frequency fluctuation	±5%
Control characteristic	Control mode	Space Vector SVPWM and Flux Vector Control
	Frequency Control range	0.1 ~ 400 Hz.
	Frequency accuracy	Digital setting 0.01%, Analog instruction 0.1% (Max frequency)
	Frequency resolution	Digital instruction 0.1Hz, Analog instruction 0.1Hz.
	Accelerated\ decelerated time	0.0 ~3600s, four accelerate/decelerated time settings available
	Multi Speed running	Build-in program
	Build-in PI	Easy to consist a simple automatic control system
	Build-in counter	Automatically controlled Production line can be achieved
	Overload capacity	G Type - 150% rated current for 1 min. P type - 120% rated current for 1 min
	Braking torque	About 20% (with brake resistor is about 150%)
	V/F mode	3 preset V/F mode and V/F program
	Automatic Energy saving operation	Changes the V/F curve according to the load to save energy
	Automatic Voltage Regulation	Regulates the voltage automatically when there is change in grid voltage
Operation function	Operation Commands	Keypad and External terminals
	Frequency Setting	Digital setting, Analog Voltage setting, Analog Current setting
	Input signal	Forward/Reverse, Jogging selection, Multi Speed Control, Regular Stopping
	Output signal	Fault Alarm Output (250V/2A Contact), Open Collector Output

Protection functions	Over Current, Over Voltage, Under Voltage, Over heat, Overload, Phase loss	
Display	Parameters setting, Running status and fault display	
Operating conditions	Operating environment	Temperature:10 ~ 40 Degree C, Humidity: < 90%, No condensation, IP20
	Operations area	Indoor, <1000m altitude above sea level
	Storage Temperature	-20 ~ +60 Degree C
	Vibration	<5.9 m/s ² (0.6g)

10-3 Dimension for Installation

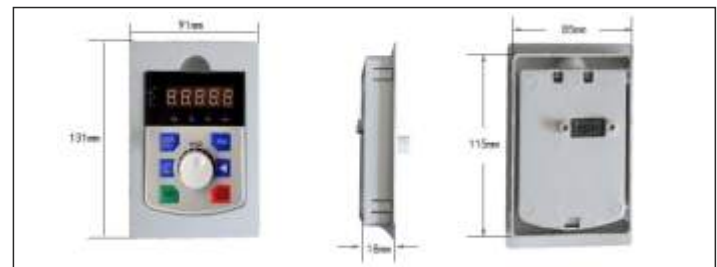
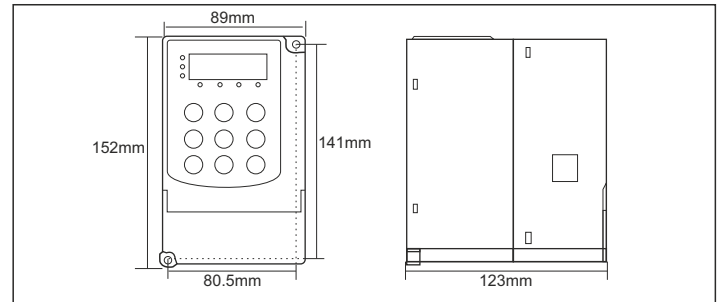

Product Code	Mounting Dimension		Dimension			Pore Diameter (mm)
	length (mm)	wide (mm)	length (mm)	wide (mm)	height (mm)	
1 HP ~ 3HP	141	80.5	152	89	123	5.2
1 HP ~ 3HP Keyboard installation dimension : length= 115mm, width= 85mm						

For FD200 Series:

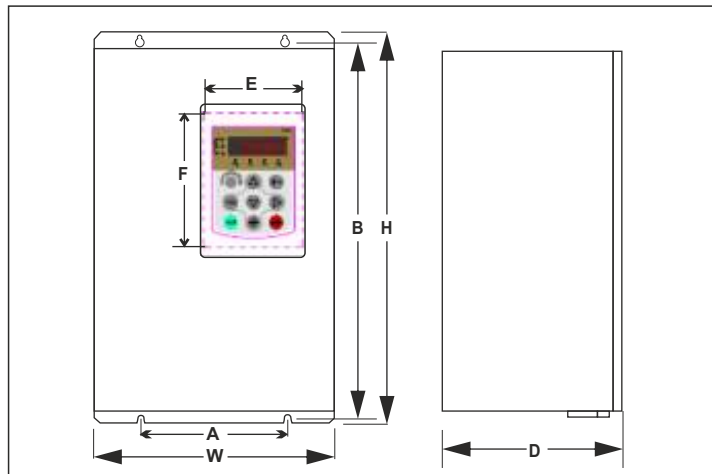

Product Code	Mounting Dimension		Dimension			Pore Diameter (mm)
	A (mm)	B (mm)	H (mm)	W (mm)	D (mm)	
FD200-3-075-C-CE	148	235	247	160	190	f 5.5
FD200-3-100-C-CE						
FD200-3-150-C-CE	205	305	320	220	205	f 5.5
FD200-3-200-C-CE						
FD200-3-250-C-CE	180	416	432	255	234.5	f 7
FD200-3-300-C-CE						
FD200-3-400-C-CE						
FD200-3-500-C-CE	244	497	518	300	260	f 9
FD200-3-600-C-CE						
FD200-3-750-C-CE						
FD200-3-1000-C-CE	300	598	620	390	300	f 11

FD200 - 7.5HP-100HP Keyboard tap installation hole size : E=85mm ; F=115mm long.

10-4 Table of Parameter Settings for operator

Customer Name		Model	
Operational environment		Telephone	
Address			
Parameter Code	Settings	Parameter Code	Settings